

---

**Pacific Northwest  
National Laboratory**

Operated by Battelle for the  
U.S. Department of Energy

**Task Report for the Energy Efficient and  
Affordable Small Commercial and Residential  
Buildings Research Program**

**Project 2.5 - Pattern-Recognition Based  
Fault Detection and Diagnostics**

**Automated Diagnostics Software  
Requirements Specification Version 1.1**

D. Sisk  
M. Brambley

T. A. Carlon  
R. S. Briggs

August 2003



Prepared for the U.S. Department of Energy  
under Contract DE-AC06-76RL01830

---

## DISCLAIMER

This report was prepared as an account of work sponsored by an agency of the United States Government. Neither the United States Government nor any agency thereof, nor Battelle Memorial Institute, nor any of their employees, makes **any warranty, express or implied, or assumes any legal liability or responsibility for the accuracy, completeness, or usefulness of any information, apparatus, product, or process disclosed, or represents that its use would not infringe privately owned rights**. Reference herein to any specific commercial product, process, or service by trade name, trademark, manufacturer, or otherwise does not necessarily constitute or imply its endorsement, recommendation, or favoring by the United States Government or any agency thereof, or Battelle Memorial Institute. The views and opinions of authors expressed herein do not necessarily state or reflect those of the United States Government or any agency thereof.

PACIFIC NORTHWEST NATIONAL LABORATORY  
*operated by*  
BATTELLE  
*for the*  
UNITED STATES DEPARTMENT OF ENERGY  
*under Contract DE-AC06-76RL01830*

Printed in the United States of America

Available to DOE and DOE contractors from the  
Office of Scientific and Technical Information,  
P.O. Box 62, Oak Ridge, TN 37831-0062;  
ph: (865) 576-8401  
fax: (865) 576-5728  
email: [reports@adonis.osti.gov](mailto:reports@adonis.osti.gov)

Available to the public from the National Technical Information Service,  
U.S. Department of Commerce, 5285 Port Royal Rd., Springfield, VA 22161  
ph: (800) 553-6847  
fax: (703) 605-6900  
email: [orders@ntis.fedworld.gov](mailto:orders@ntis.fedworld.gov)  
online ordering: <http://www.ntis.gov/ordering.htm>



This document was printed on recycled paper.

**Final Report for the Energy Efficient and  
Affordable Small Commercial and Residential  
Buildings Research Program**

**Project 2.5 – Pattern-Recognition based Fault  
Detection and Diagnostics**

**Automated Diagnostics Software Requirements  
Specification  
Version 1.1**

D. R. Sisk  
M. R. Brambley  
T. A. Carlon  
R. S. Briggs

August 2003

Prepared for  
the U.S. Department of Energy  
under Contract DE-AC06-76RL01830

Pacific Northwest National Laboratory  
Richland, Washington 99352

Automated Diagnostics	Version: 1.1
Software Requirements Specification	Date: 8/28/2003
Software Requirements Specification 1-1.DOC 8/29/2003	

## Revision History

Date	Version	Description	Author
7/31/2002	1.0	Initial version	DR Sisk, MR Brambley, TA Carlon, RS Briggs
8/30/2003	1.1	Revised version with Boiler Diagnostics	DR Sisk, MR Brambley, TA Carlon, RS Briggs

Automated Diagnostics	Version: 1.1
Software Requirements Specification	Date: 8/28/2003
Software Requirements Specification 1-1.DOC 8/29/2003	

Automated Diagnostics	Version: 1.1
Software Requirements Specification	Date: 8/28/2003
Software Requirements Specification 1-1.DOC 8/29/2003	

## Table of Contents

1.	Introduction	1
1.1	Purpose	1
1.2	Scope	1
1.3	Definitions, Acronyms and Abbreviations	1
1.4	References	3
1.5	Overview	3
2.	Overall Description	4
2.1	Product Perspective	4
2.2	Product Functions	5
2.3	User and Environment Characteristics	6
2.4	General Constraints	6
2.5	Use-Case Model Survey	7
2.5.1	Introduction	7
3.	Requirements	8
3.1	Use-Case Specifications	9
3.1.1	Start and Stop Diagnostics Use Case	9
3.1.2	Browse Current Diagnostics Use Case	11
3.1.3	Browse Historical Diagnostics Use Case	12
3.1.4	Configure Diagnostics Use Case	14
3.1.5	Authenticate User	15
3.2	Functionality	16
3.2.1	General	16
3.2.2	Preprocessing	16
3.2.3	Diagnostic Process	19
3.2.4	Output Processing	30
3.3	Usability	30
3.3.1	User Interface	30
3.4	Supportability	31
3.4.1	Error Reporting	31
3.5	Interfaces	31
3.5.1	User Interfaces	31
3.6	Security	38
3.7	Other Requirements	38
4.	Appendix A: Data Flow Diagrams of Diagnostic Processes for Chillers, Cooling Towers, and Chilled-Water Distribution	39
5.	Appendix B: Chiller, Cooling Tower, and Chilled-Water Distribution Data Dictionary	122
6.	Appendix C: Data Flow Diagrams for Boiler Diagnostic Processes	139
7.	Appendix D: Data Dictionary for Boilers	163

Automated Diagnostics	Version: 1.1
Software Requirements Specification	Date: 8/28/2003
Software Requirements Specification 1-1.DOC 8/29/2003	

# Software Requirements Specification

## 1. Introduction

This document specifies requirements for a computerized automated diagnostic tool for the detection of faults in certain heating, ventilation, and air-conditioning (HVAC) system components. The automated diagnostic tool is being developed for Architectural Energy Corporation (AEC) by Battelle as part of a program sponsored by the California Energy Commission (CEC). Supplemental cost-share funds are provided by U.S. Department of Energy through the Pacific Northwest National Laboratory (PNNL).

### 1.1 Purpose

This Requirements Specification (RS) specifies the essential capabilities required of the automated diagnostic tool. The purpose of this document is to clarify for AEC, the California Energy Commission (CEC), the Office of Buildings Programs, Office of Energy Efficiency and Renewable Energy (EERN) of the U.S. Department of Energy, and the project team the results that must be achieved by the automated diagnostic tool. Any illustrative model presented in this document is used solely to explain the requirements and is NOT intended to address design or implementation issues.

This SRS also specifies key AEC, CEC, and EERN requirements for project deliverables, including documentation.

### 1.2 Scope

The automated diagnostic tool detects and identifies faults in chillers and cooling tower subsystems of HVAC units using sensed data acquired from the unit, unit specifications, unit installation and configuration data, and unit operation data (such as schedules). The tool is a software product that will be utilized primarily by building operators and facilities managers and only secondarily by HVAC service technicians, energy service providers, and operation supervisors. Building operators will use the tool to monitor units for which they are responsible, perhaps monitoring from a central control room within the building. Service technicians will utilize the product on site during repair and maintenance visits or off site between visits. Energy service providers, responsible for a number of customers and facilities, will use the product to monitor a number of units remotely, possibly in many different buildings, checking for inefficiencies and problems requiring dispatch of service personnel. Finally, building operator supervisors will use the tool to guide decisions on the assignment of operators and prioritization of work. The tool will provide the user with a visual indication of faults, descriptive information concerning the faults and their causes, and suggested corrective actions. The tool will store the results of diagnostics for subsequent retrieval and use.

The software requirements described in this document are applicable to HVAC systems and associated subsystems. Such subsystems can include chillers, cooling towers, and boilers. However, the initial version of the tool will focus on diagnostics for chillers and cooling towers only. The tool will automate diagnostic processes hitherto performed through a visual analysis of graphical data by a human expert.

The "Product Overview" section describes factors that affect the software and its requirements. The "Concept Example" appendix describes how the software would function in an example situation.

### 1.3 Definitions, Acronyms and Abbreviations

Some of the following definitions are taken or adapted from IEEE Std 610.12-1990 (IEEE 1993a) and IEEE Std 830-1984 (IEEE 1993b).

Automated Diagnostics	Version: 1.1
Software Requirements Specification	Date: 8/28/2003
Software Requirements Specification 1-1.DOC 8/29/2003	

**Authenticate** — the process by which the tool establishes the identity and privileges of the user by obtaining an identifier and password from the user and checking it against a database of predefined users. The user becomes authenticated when the identifier and password match one of the predefined users in the tool's database.

**component** — one of the parts that make up a software system. A component may be subdivided into other components [IEEE Std 610.12-1990]. Note: For the purpose of this specification, the term “component” will be used in preference to the term “module”

**diagnostic result** — the output of the diagnostic processing. This can either be an identified fault condition or the confirmation of the absence of a fault condition.

**fixed data** — data describing the characteristics of the unit under diagnosis, for example, specifications and design information, operating characteristics, set points, installation and configuration data, and operation data (such as schedules) that do not change on a regular basis.

**functional requirement** — a requirement that specifies a function that a software system or software component must be able to perform [IEEE Std 610.12-1990]. In this requirements specification, functional requirements specify how the inputs to the software product should be transformed into outputs [IEEE Std 830-1984].

**interface requirement** — a requirement that specifies an external item with which a software system or software component must interact, or that sets forth constraints on formats, timing, or other factors caused by such an interaction [IEEE Std 610.12-1990]

**module** — see *component*

**product** — (for this document) a software system or software component—along with any necessary data and documentation—for which requirements are specified in a *requirements specification*

**requirement** — (1) a condition or capability needed by a customer to solve a problem or achieve an objective; (2) a condition or capability that must be met or possessed by a software *system* or software *component* to satisfy a contract, standard, *specification*, or other formally imposed document; (3) a documented representation of a condition or capability as in (1) or (2) [adapted from IEEE Std 610.12-1990]

**requirements specification (RS)** — a document of the essential *requirements* (functions, design constraints, and attributes) of the software and/or hardware and their external interfaces [adapted from IEEE Std 610.12-1990]

**RS** — *requirements specification*



Automated Diagnostics	Version: 1.1
Software Requirements Specification	Date: 8/28/2003
Software Requirements Specification 1-1.DOC 8/29/2003	

**Sensed data** — data that are measured through electronic or mechanical detection. Typically this data varies at such a rate, e.g., in real time, hourly, daily, weekly, or is otherwise difficult to estimate or model such that an accurate characterization of it can only be gained through such detection. This data includes temperatures, pressures, electrical current, machine state, etc.

**software system** — a collection of software *components* related in such a way as to produce a result greater than what their parts, separately, could produce

**subsystem** — a discrete part of an HVAC system, e.g., chiller or cooling tower.

**unit** — a complete HVAC system

**usability** — the ease with which a user can learn to operate, prepare inputs for, and interpret outputs of a software system or software component [IEEE Std 610.12-1990].

#### 1.4 References

The following are references supporting these specifications:

#### 1.5 Overview

**Product Overview** -- This section provides a descriptive overview of the automated diagnostic tool, its users and operating environment, and general factors that affect requirements. It lays the foundation for understanding the specific requirements that follow.

**Specific requirements** are specified in the following categories:

Category	Descriptions
Overall Description	An overview of the expected product use and context including user characteristics, constraints, and assumptions.
Functional Requirements	describes the core capability and operating characteristics required of the diagnostic tool by the client.
External Interface Requirements	includes general user interface requirements and logical characteristics of interfaces between the automated diagnostic tool, data acquisition system, and data storage system. Specific user interface requirements are being developed independently as part of the Phase A Prototype.
Security Requirements	specifies requirements for safeguarding customer data
Other Requirements	includes special operations required by end users, and documentation requirements specified by the client.

Automated Diagnostics	Version: 1.1
Software Requirements Specification	Date: 8/28/2003
Software Requirements Specification 1-1.DOC 8/29/2003	

**Appendix A: Data Flow Diagrams of Diagnostic Processes for Chillers, Cooling Towers and Chilled Water Distribution** provides diagrams showing the data flows and data-processing that lead from fixed data and sensed data to diagnostic conclusions.

**Appendix B: Data Dictionary for Chillers, Cooling Towers and Chilled Water Distribution** provides a tabular listing of known system data corresponding to their use in Appendix A.

**Appendix C: Data Flow Diagrams for Basic Boiler Diagnostics** provides diagrams and mini-specs showing data flows and data processing that lead from fixed data and sensed data to diagnostic conclusions.

**Appendix D: Data Dictionary for Boilers** provides a tabular listing of all known system data elements corresponding to their use in Appendix C.

## 2. Overall Description

The following overview of the automated diagnostic tool supplies context for the specific requirements presented in later sections. The purpose of this information is to make the specific requirements easier to understand. All specific requirements are *numbered* in later sections.

### 2.1 Product Perspective

Currently, diagnostics on HVAC units and subsystems are performed largely on a manual basis. Sensed data, e.g., temperatures and pressures, are obtained from one or more data acquisition devices. These devices measure and store sensed data over periods of several days to several weeks. Prior to the diagnostic process, data from these devices is input to graphical display software for visual inspection by a human expert. The expert, relying on technical expertise and results of previous diagnostic experience, evaluates the condition of the unit and subsystems based on visual plots of the data. This process is depicted in Figure 1.

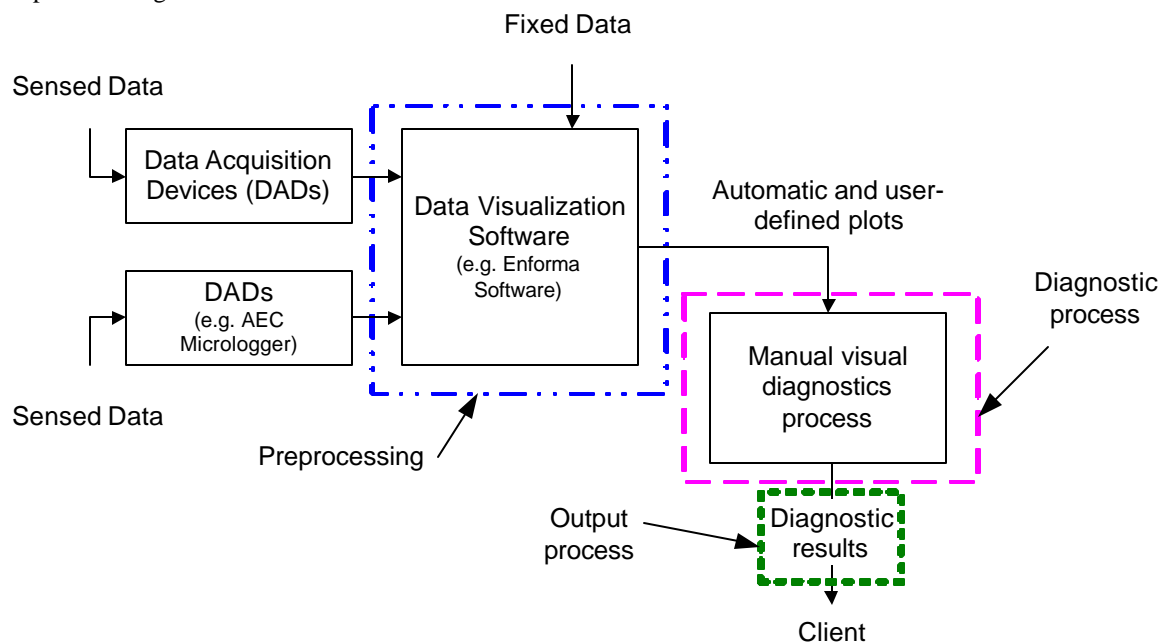

**Figure 1. Current HVAC Diagnostic Process**

Automated Diagnostics	Version: 1.1
Software Requirements Specification	Date: 8/28/2003
Software Requirements Specification 1-1.DOC 8/29/2003	

The process depicted in Figure 1 can be partitioned into three logical components. These components are delineated in the diagram by dashed lines and are the data-preprocessing component, the diagnostic component, and output component. The diagnostic tool described in this document will replace the current process with an automated one based on algorithms derived from expert practices. These algorithms operate without the need for data visualization or human expert input. Diagnostic results will be displayed to the user and stored for subsequent retrieval and analysis. For the purposes of this document, the automated diagnostic tool will be assumed to preserve the logical construction of the current process. This construction is depicted in Figure 2.

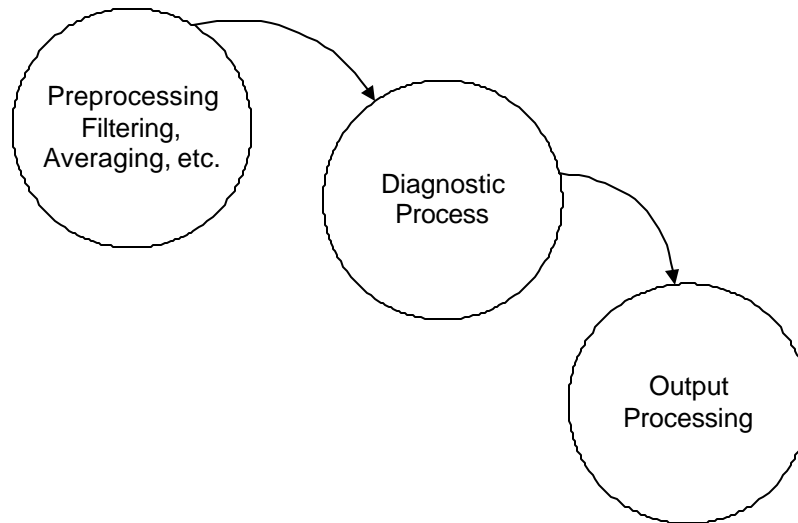

**Figure 2. Logical Construction of HVAC Diagnostic Process**

## 2.2 Product Functions

As previously stated, the functionality of the automated diagnostic tool can be partitioned into three logical components: the data preprocessing component, the diagnostic component, and the output component.

The data-preprocessing component obtains data describing the subsystem under diagnosis and reduces, filters, and otherwise prepares the data for input to the diagnostic component. This data includes sensed data, e.g., temperatures, pressures, electrical current, machine state, etc., as well as fixed data describing the characteristics of the subsystem under diagnosis, for example, specifications and design information, operating characteristics and set points, etc. The data may be processed through averaging, trending, or other statistical analysis. Sensed data can originate from data acquisition hardware either in real time or at some arbitrary time after acquisition. Fixed data will generally be compiled prior to operation of the diagnostic tool and be obtained from permanent storage when needed. Specific requirements will be placed on the data-preprocessing component only with respect to types of data to be input and the format and interface requirements of this input. However, the component is described here to provide insight into the operation of the software.

The diagnostic component will detect and identify faults in the operation of HVAC subsystems based on sensed and fixed data input from the data-preprocessing component. The diagnostic algorithms used for fault detection will be derived from current expert practices by AEC. The faults identified by the

Automated Diagnostics	Version: 1.1
Software Requirements Specification	Date: 8/28/2003
Software Requirements Specification 1-1.DOC 8/29/2003	

diagnostic will be enumerated and described under the functional requirements section.

The output component will display and record results output from the diagnostic component. The results of the diagnostics will be displayed to the user in a simple, graphical and textual format. The results will also be stored to permanent storage for subsequent retrieval and analysis.

### 2.3 User and Environment Characteristics

As previously stated, users of the automated diagnostic tool will include service technicians, energy service providers, building operators, and building operator supervisors. Installed platforms could include portable computers, handheld devices, and personal workstations in control rooms and offices. Installed platforms may communicate with the HVAC unit under diagnosis using wireless interfaces, direct point-to-point connections, or over Internet or local area network. Platform operating systems will be initially restricted to Microsoft Windows-compatible systems.

The computer expertise of the user base could vary over a wide range. Some users could be quite sophisticated, others familiar with only the most rudimentary computer-based tasks. However, it is expected that all users will have a good fundamental understanding of HVAC units. Setting up and operating the automated diagnostic tool should require minimal user input.

Service technicians are expected to use the software as often as their service tasks dictate, perhaps several times a day for periods up to about one hour, in close proximity to the HVAC unit and possibly out of doors. They may also set up the diagnostic tool to collect data continuously offsite at their offices and inspect the data periodically to identify faults or confirm proper operation. Building operators are expected to use the software on an occasional basis every day. The tool would collect data and process it continuously but the operators would only check the results periodically. They may view results for only a few seconds to check the status of equipment while passing through a control room or may sit at a monitor for several minutes more carefully inspecting the diagnostic results and other information available on the tool's display. Energy service providers and building operator supervisors could potentially use the software in a more continuous mode, allowing it to operate undisturbed for many hours or days to record diagnostic results over a period of time.

See the "Concept Example" appendix for a detailed example of how the automated diagnostic tool will be used.

### 2.4 General Constraints

The automated diagnostic tool must support a wide variety of users with respect to computer expertise. In addition, different users will have different expectations for the tool with respect to data presentation and functionality. For instance, some users will simply require an immediate diagnostic result while other users may be interested in diagnostic results generated over an arbitrary time that can be subsequently reviewed.

The tool must provide a capability to manually input and edit "fixed" data, i.e., data that does not vary in real-time. Such data includes HVAC unit set points, specifications, and configuration information. This data must be stored for subsequent use by the diagnostic tool for review and verification by other users and management. The tool should provide for configuration management of fixed data.

Automated Diagnostics	Version: 1.1
Software Requirements Specification	Date: 8/28/2003
Software Requirements Specification 1-1.DOC 8/29/2003	

The user must have the capability to configure the tool for continuous diagnostic analysis over an indefinite period of time. In this mode, the tool will record diagnostic results for subsequent review. No printed reports will be required of the tool, but the tool must print screen images of diagnostic results and historical data at user request and must provide long term storage of diagnostic results and permit the user to supply metadata relevant to the results, e.g., location, HVAC serial number, model number, user name, date, etc.

The tool will not provide capability for additional user-defined analysis of the diagnostic results, results will be provided in a simple, final, definitive manner. However, the tool may provide the user the capability to adjust the sensitivity of the diagnostic algorithms to increase the probability of exposing typically undetected diagnostic events or concealing detected diagnostic events (including false detections).

The tool will be capable of obtaining sensed data from a variety of sources. Such sources should include real-time data acquisition devices and data files containing previously acquired data.

The current version of the tool will include diagnostic algorithms for cooling tower and chiller subsystems of HVAC units. However, the design of the software should support the incorporation of diagnostic algorithms for additional HVAC subsystems. In addition, the tool should support modification or replacement of existing diagnostic algorithms.

The automated diagnostic tool will be restricted to Microsoft Windows-compatible operating systems.

## 2.5 Use-Case Model Survey

This section provides an overview of the use case model that describes the operation of the user interface. Actual use cases that specifically define the operation of the user interface are presented in the requirements section.

### 2.5.1 Introduction

The use case model consists of five use cases as depicted in Figure 3. The main actor in the use case model is the human user. This actor is generalized as "User". The User can be further specified as a general user or administrator. The general user has no ability to modify system settings. The administrator user is able to modify certain settings. The use case "Start and Stop Diagnostics" describes the process by which the administrator user activates and ceases diagnostic processing. The use case "Browse Current Diagnostics" describes the process by which the user views current diagnostic results. The use case "Browse Historical Diagnostics" describes the process by which the user views historical diagnostic results. The use case "Configure Diagnostics" describes the process by which the administrator user adjusts diagnostic parameters used in the diagnostic process. The use case "Authenticate User" describes the process by which the user makes known to the tool the privileges to which they are entitled.

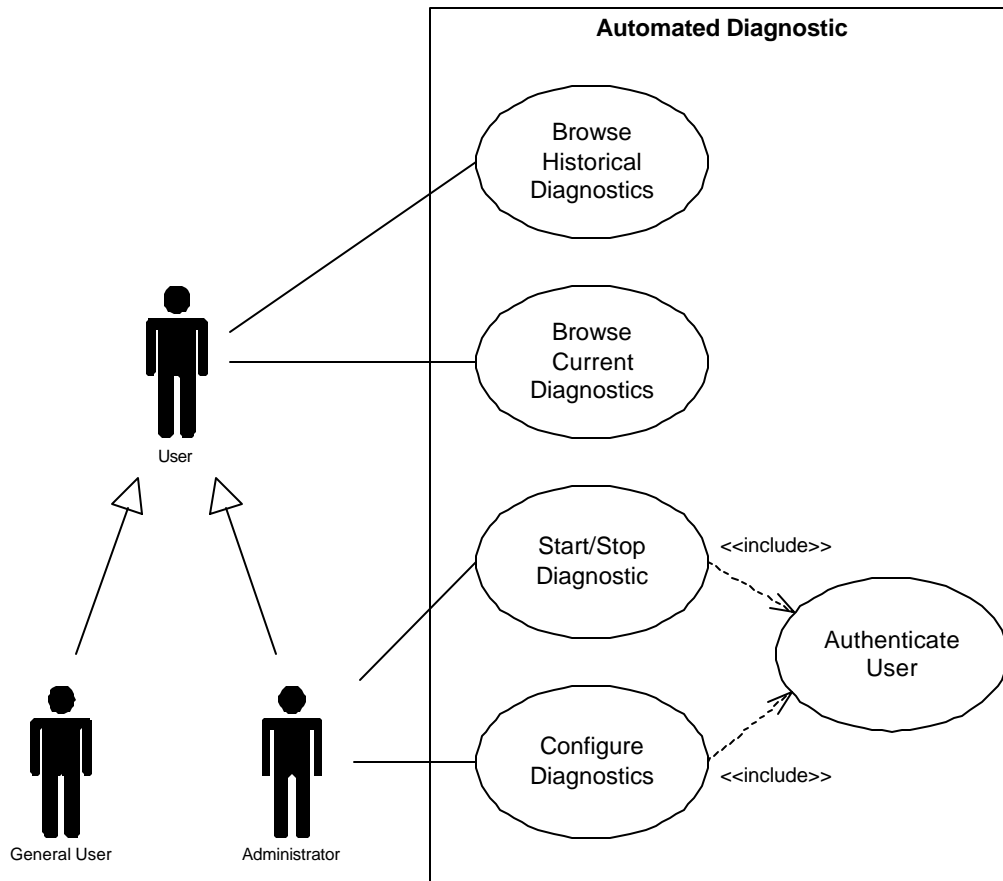

**Figure 3. Use Case Model**

### 3. Requirements

The requirements in this document are organized according to the categories listed in Table 1.

**Table 1. Categories of Software Requirements**

Requirement Category	General Description and Purpose
<b>Use-Case Specifications</b>	specify, in terms of use cases, the expected interactions and behavior of the software with respect to the defined actors.
<b>Functionality</b>	specify functions that a system or component must be able to perform — the fundamental software actions that transform inputs into outputs

Automated Diagnostics	Version: 1.1
Software Requirements Specification	Date: 8/28/2003
Software Requirements Specification 1-1.DOC 8/29/2003	

<b>Usability</b>	specify factors affecting how easily users can learn to operate a system or component, prepare its inputs, and interpret its outputs
<b>Supportability</b>	include requirements affecting how easily a system or component can be maintained to meet its original requirements or extended to meet modified requirements
<b>Interfaces</b>	specify requirements for user, hardware, software, and communication interfaces, as applicable.
<b>Security</b>	specify needs for protecting the software from accidental or malicious access, use, modification, destruction, or disclosure
<b>Other Requirements</b>	include special requirements that do not fit into previous categories

### 3.1 Use-Case Specifications

This section describes the five main use cases describing the functionality of the user interface. These use cases are “Start and Stop Diagnostics”, “Browse Current Diagnostics”, “Browse Historical Diagnostics”, “Configure Diagnostics”, and “Authenticate User”. The use cases “Start and Stop Diagnostics” and “Configure Diagnostics” include the use case “Authenticate User”.

#### 3.1.1 Start and Stop Diagnostics Use Case

##### 3.1.1.1 Brief Description

[This use case provides the actor the means to start and stop diagnostic processing. The actor in this case is the administrator user \(see 2.5.1\).](#)

##### 3.1.1.2 Flow of Events

The use case begins just prior to when the user launches the application.

##### 3.1.1.2.1 Basic Flow – Start Diagnostics

1. The user launches the tool by double-clicking the icon associated with the tool or typing the application’s name.
2. The tool momentarily displays a splash screen identifying the tool, identifying developing and sponsoring organizations as appropriate, and listing copyright information.
3. The tool displays the main window of the tool.
4. The user starts the diagnostic processing by selecting a menu item named “Start Diagnostics” from a drop down menu named “Status”.
5. Include (Authenticate User). If the user has the appropriate privilege (i.e., the user is the administrator user) the tool requests a confirmatory response from the user to start the diagnostic processing.
6. If the user confirms the desire to start diagnostic processing, the tool starts the processing and displays

Automated Diagnostics	Version: 1.1
Software Requirements Specification	Date: 8/28/2003
Software Requirements Specification 1-1.DOC 8/29/2003	

an animated indication that diagnostic processing is active.

7. If the user responds negatively to the confirmation, the tool does not start the diagnostic processing but the user remains authenticated.
8. If the user does not have the appropriate privilege, the tool does not start the diagnostic processing.
9. The user secures the tool by selecting a menu item named "Logout" from the drop down menu named "File".
10. The tool returns the current user's privileges to those of the general user.
11. If a period of 15 minutes elapses whereby the user does not secure the tool, the users privileges will automatically revert to those of a general user.

### 3.1.1.2.2 Alternative Flow

#### 3.1.1.2.2.1 *Stopping Diagnostic Processing*

1. The user can stop diagnostic processing at any time after the diagnostic processing has started by selecting the "Stop Diagnostics" menu item from the main menu entitled "Status".
2. If the user is not authenticated as the administrator user, include (Authenticate User) to validate privileges for stopping diagnostic processing.
3. If the user has the appropriate privilege, the tool requests confirmation to stop diagnostic processing.
4. If the user responds positively to the confirmation, the tool stops diagnostic processing and indicates the stopped condition. Otherwise the software performs no function but the user remains authenticated.
5. If the user selects the "Exit" menu item from the main menu entitled "File" and the diagnostic processing is not active, the tool exits.
6. If the user selects "Exit" and the diagnostic processing is active, include (Authenticate User), if the user is not already validated, to verify the user's privilege to stop diagnostic processing.
7. If the user is permitted to stop diagnostic processing, the tool stops the processing and exits. Otherwise, the software performs no function.

### 3.1.1.3 Special Requirements

There are no special requirements for this use case.

### 3.1.1.4 Preconditions

There are no preconditions for this use case.



Automated Diagnostics	Version: 1.1
Software Requirements Specification	Date: 8/28/2003
Software Requirements Specification 1-1.DOC 8/29/2003	

### 3.1.1.5 Postconditions

There are no postconditions for this use case.

### 3.1.1.6 Extension Points

There are no extension points for this use case.

## 3.1.2 *Browse Current Diagnostics Use Case*

### 3.1.2.1 Brief Description

[This use case provides the actor the means to view current diagnostic results. The actor in this case is the user \(see 2.5.1\).](#)

### 3.1.2.2 Flow of Events

The use case begins with the tool executing and displaying a list of buildings under diagnosis on the main (initial) window.

#### 3.1.2.2.1 Basic Flow – Browse Current Diagnostics

1. The tool displays the main (initial) window, listing buildings under diagnosis.
2. The user selects a building of interest.
3. The tool displays the subsystems window, tiled on top the main (initial) window.
4. The user selects a subsystem of interest.
5. The tool displays the condition window, tiled on top the subsystems window.
6. The user selects a diagnostic of interest.
7. The tool displays the diagnostic information window for that diagnostic.

#### 3.1.2.2.2 Alternative Flow

1. At any window except the initial window, the user may click the “Back” button to dismiss the current window and re-establish the previous window as the current window. The user may then make a new selection.
2. The user may click a button labeled “Print” on the diagnostic information window to print an image of the window.
3. The tool displays a window listing possible items to print including the diagnostic information window.
4. The user selects the diagnostic information window and clicks the “OK” button to print the window.

### 3.1.2.3 Special Requirements

There are no special requirements for this use case.

### 3.1.2.4 Preconditions

There are no preconditions for this use case.

Automated Diagnostics	Version: 1.1
Software Requirements Specification	Date: 8/28/2003
Software Requirements Specification 1-1.DOC 8/29/2003	

### 3.1.2.5 Postconditions

The diagnostic processing will not cease or be negatively impacted during the activities of this use case.

### 3.1.2.6 Extension Points

There are no extension points for this use case.

## 3.1.3 *Browse Historical Diagnostics Use Case*

### 3.1.3.1 Brief Description

This use case provides the actor the means to view historical diagnostic results. The actor in this case is the user (see 2.5.1).

### 3.1.3.2 Flow of Events

The use case begins with the tool displaying the diagnostic information window, itself displaying a description of a diagnostic of interest.

#### 3.1.3.2.3 Basic Flow – Browse Historical Diagnostics

1. The user clicks the “History” button.
2. The tool displays the diagnostic history window depicting the historical results of the selected condition of interest over the default viewing period in the form of a color map. The window provides a scroll bar for scrolling through historical results if data are available prior to the default viewing period. The default viewing period extends backward one week prior to the current date. Sliding the scroll bar does not change the viewing period displayed. The default time resolution for the window is one hour.
3. The user slides the scroll bar backward or forward to view previous results up to the current time.
4. The tool displays the results within a viewing period of one week, adding results to the beginning or ending of the period while dropping results of the opposite end. The tool does not change the viewing period.
5. The user may close the diagnostic history window by clicking the “Close” button.
6. The tool dismisses the diagnostic history window and the diagnostic information window and makes the condition window the current window.

#### 3.1.3.2.4 Alternative Flows

##### 3.1.3.2.4.1 *Changing the Viewing Period*

1. The user selects a new viewing period from a list of periods provided by the tool.
2. The tool redisplay the historically data over the new viewing period.

##### 3.1.3.2.4.2 *Zooming*

1. The user selects a period of time within the displayed viewing period over which to expand or contract in time.

Automated Diagnostics	Version: 1.1
Software Requirements Specification	Date: 8/28/2003
Software Requirements Specification 1-1.DOC 8/29/2003	

2. The tool expands or contracts the selected period. If expanding, the selected period becomes the new viewing period. If contracting, the new viewing period becomes twice as long as the selected period and encloses it.

#### 3.1.3.2.4.3 *Displaying Historical Diagnostic Information*

1. The user double-clicks a cell in the history window.
2. The tool dismisses the current diagnostic information window if displayed. After a noticeable delay of approximately one second, the tool displays the diagnostic information window associated with the cell selected.

#### 3.1.3.2.4.4 *Browsing Arbitrary History Intervals*

1. The user specifies a start time and end time for an historical interval of interest using calendar controls.
2. The tool displays historical results beginning with the first result on or after the specified start time up to the end time. The view is confined to the previously selected viewing period.

#### 3.1.3.2.4.5 *General Alternative Flows*

1. At the diagnostic information window, the user may click the "Close" button to dismiss the window and make the condition window the current window if the diagnostic history window is not displayed.
2. If the user attempts to close the diagnostic information window and the diagnostic history window is still displayed, the diagnostic information window is dismissed but the diagnostic history window remains.
3. If the condition window is closed, then both the diagnostic information and diagnostic history windows are closed if open.
4. If the user does not specify an end time for the history interval in 3.1.3.2.4.1 Browsing Arbitrary History Intervals (1), it defaults to the current time.

#### 3.1.3.3 Special Requirements

There are no special requirements for this use case.

#### 3.1.3.4 Preconditions

The diagnostic processing need not be active for this use case. A diagnostic information window must be displayed for this use case to begin.

#### 3.1.3.5 Postconditions

The diagnostic processing will not cease or be negatively impacted during the activities of this use case.

Automated Diagnostics	Version: 1.1
Software Requirements Specification	Date: 8/28/2003
Software Requirements Specification 1-1.DOC 8/29/2003	

### 3.1.3.6 Extension Points

There are no extension points for this use case.

## 3.1.4 *Configure Diagnostics Use Case*

### 3.1.4.1 Brief Description

This use case provides the actor the means to configure the diagnostic tool. This includes defining the buildings containing systems to be diagnosed, defining the systems themselves, specifying equipment setpoints, selecting diagnostic sensitivity, and modifying fixed data. The actor in this case is the administrator user (see 2.5.1).

### 3.1.4.2 Flow of Events

The diagnostic tool is executing prior to the processing of this use case and only the main window of the tool is displayed.

#### 3.1.4.2.5 Basic Flow – Configure Diagnostics

1. When presented with the main window, the user may select the “Configure Diagnostics” menu item from the menu entitled “File”.
2. If the user has not already been authenticated as the administrator user, include (Authenticate User).
3. If the user has the appropriate privilege, the tool displays the configuration window.
4. The user may click the “Recall” button to read previously saved changes from a disk file or database.
5. The tool populates the window with the data from the disk file.
6. The user makes the desired changes to the configuration and can click the button labeled “Save” to save the changes. Otherwise, the user can click the button labeled “Close”.
7. If the user clicks the button labeled “Save”, the tool will request confirmation to save the changes.
8. If the user confirms, the tool will request a name for the disk file in which to save the modified data to permanent storage.
9. The user will enter a name for the file or cancel the operation.
10. If the user enters a name for the file, the tool will save the changes. If the user cancels the operation, the tool will perform no function.
11. If the tool completes the save operation, the tool will ask the user if the changes are to be relayed to the diagnostic processing for immediate use.
12. If the user confirms the changes are to be relayed to the diagnostic processing, the tool relays the changes if the processing is currently active. Otherwise, the tool does not relay the changes.
13. If the user clicks the button labeled “Close”, the tool will request confirmation for the close and the potential loss of any changes.

Automated Diagnostics	Version: 1.1
Software Requirements Specification	Date: 8/28/2003
Software Requirements Specification 1-1.DOC 8/29/2003	

14. If the user confirms, the tool will dismiss the configuration window, ignoring any changes and returns the user to the main window. If the user rejects the initial desire to close, the tool will perform no function.

#### 3.1.4.2.6 Alternative Flows

There are no alternative flows for this use case.

#### 3.1.4.3 Special Requirements

There are not special requirements for this use case.

#### 3.1.4.4 Preconditions

The main window of the tool must be the only window active for the tool prior to execution of this use case.

#### 3.1.4.5 Postconditions

Any changes made by the administrator user to the diagnostic tool will take affect immediately if requested by the user.

#### 3.1.4.6 Extension Points

There are no extension points for this use case.

### 3.1.5 *Authenticate User*

#### 3.1.5.1 Brief Description

[This use case establishes the privileges of the user for certain functions of the tool.](#)

#### 3.1.5.2 Flow of Events

This use case begins when another use case requires its instantiation.

##### 3.1.5.2.7 Basic Flow

1. The tool displays a window for entry of authenticating information, i.e., user name and password, to validate and establish the privileges of the user.
2. The user enters their user name and password.
3. The tool attempts to authenticate the user and indicates whether authentication has succeeded or not.
4. If authentication is unsuccessful, the user is returned to the authentication window to reenter the information.
5. The tool permits three attempts at authentication before dismissing the authentication window and returning the user to the previous window.
6. The user may cancel the authentication process at any time and return to the previous window.

##### 3.1.5.2.8 Alternative Flows

There are no alternative flows for this use case.

##### 3.1.5.2.9 Special Requirements

There are no special requirements for this use case.

Automated Diagnostics	Version: 1.1
Software Requirements Specification	Date: 8/28/2003
Software Requirements Specification 1-1.DOC 8/29/2003	

### 3.1.5.2.10 Preconditions

There are no preconditions for this use case.

### 3.1.5.2.11 Postconditions

There are no postconditions for this use case.

### 3.1.5.2.12 Extension Points

There are no extension points for this use case.

## 3.2 Functionality

This section describes the functional requirements of the software, that is, requirements describing the core functions the software must perform. This section begins with general requirements relevant to the tool as a whole. Subsequently, requirements are organized by the logical construction of the tool as data processing progresses from preprocessing to output processing.

### 3.2.1 General

The following general requirements pertain equally to the logical partitions of the tool.

3.2.1.1 Users of the tool shall be classified into two types. The first type, general user, shall only be permitted to utilize a limited set of the capabilities of the tool. These capabilities are listed in Table 2. Typically a general user is only permitted to view the results of diagnostic processing either current or historical. The second type, administrator, shall be permitted all the privileges of the general user plus those identified in Table 2. The administrator is permitted all the privileges of the general user in addition to the privileges to configure the system and modify fixed data and diagnostic settings.

**Table 2 User Privileges**

General User Privileges	Administrator Privileges Beyond General User's
Browse Current Diagnostics	Start/Stop Diagnostics
Browse Historical Diagnostics	Configure Diagnostics
	Define sensed data input units

### 3.2.2 Preprocessing

The automated diagnostic tool shall input sensed data in real time from data acquisition devices and the HVAC unit under diagnosis as well as from data files containing previously acquired data, though not simultaneously. In addition, the tool shall input fixed data provided by the user. Sensed and fixed data used by the tool in performing automated diagnostics shall be stored to permanent storage for post-analysis by the diagnostic process and viewing of the results.

3.2.2.1 The tool shall input sensed data in real time from data acquisition devices and the HVAC unit under diagnosis. The absolute time of input will be associated with each sensed data item for its complete lifecycle, including permanent storage. The time will be determined at the instant the acquisition of the sensed data is complete.

Automated Diagnostics	Version: 1.1
Software Requirements Specification	Date: 8/28/2003
Software Requirements Specification 1-1.DOC 8/29/2003	

3.2.2.2 The tool shall permit sensed data to be input from an electronic file, though not simultaneously with sensed data from external acquisition hardware. When inputting sensed data from an electronic file, only one file shall be used containing all necessary sensed data. The file shall be an ASCII text file containing only columns delimited by a single tab character or single comma. The file shall begin with a required header. The first column of the header will list, at a minimum, the entries "Building Identifier" and "Input Identifier" in that order. Following columns on the Input Identifier row will list integer input identifiers. Following columns on the Building Identifier row will list corresponding integer building identifiers for the inputs. One or more comment rows may exist above and below these required rows. These comment rows are identified by a '#' as the first character of the first column. These rows are ignored by the tool. The first uncommented column in the file after the required headers shall list the absolute time, in ascending order, associated with all entries in subsequent columns of the row. Each additional column in the file shall pertain to one and only one sensed parameter. Data values in the same row of the file correspond to identical time values. All columns in the file shall have the same number of rows. An example input file is presented in Table 3. When the tool is processing sensed data from an input file, the tool is considered to be operating in "batch mode".

**Table 3 Example Input Data File Reflecting Specified Format**

#Test Run			
#Sensor Name	Temperature	Flow	Pressure
Building Identifier	1	1	2
Input Identifier	1	2	3
12/14/01 8:43	12.4	35.8	407.3
12/14/01 13:30	5.4	955.1	971.0
12/14/01 20:01	123.5	576.21	491.4

3.2.2.3 Each sensed data item will be qualified as to its certitude during the acquisition process. Sensed data will be considered in doubt if acquisition of the data was not possible (for example, if an error occurs during communication with the acquisition hardware), or the data is outside the range of possible values. Otherwise, the sensor value will be deemed accurately acquired.

3.2.2.4 The software will deem sensed data in doubt if acquisition of the data is not possible, due to communication failures, for a default number of successive samples. The default is dependent on sensor type. These default values are specified in Table 4. The number of successive samples for a given sensor type shall be modifiable by the administrator. Data not successfully acquired will be deemed "missing data".

**Table 4 Default Number of Failed Successive Samples Indicating Sensor Data Acquisition Problem.**

Sensor Type	Default Number of Failed Successive Samples
Temperature	3
Current	3
Switch	3

Automated Diagnostics	Version: 1.1
Software Requirements Specification	Date: 8/28/2003
Software Requirements Specification 1-1.DOC 8/29/2003	

3.2.2.5 Sensed data used in or supporting diagnostic analyses shall be saved to permanent storage.

3.2.2.6 The occurrence of missing data shall be indicated in permanent storage by a unique and obvious place holder or indicator, e.g., a null value or sequence of characters that cannot be confused with non-missing data.

3.2.2.7 Sensed data input to the tool shall be stored to permanent storage with a precision of three significant figures.

3.2.2.8 Sensed data input to the tool shall be validated with respect to its expected range of values. Sensed data shall be assigned the ranges listed in Table 5 by default.

**Table 5 Default sensed data expected ranges**

Sensor	Expected Minimum Value	Expected Maximum Value
Ambient Temperature	-40 F	130 F
Ambient wet-bulb Temperature	-40 F	100F
Chilled Water Supply Temperature	30F	80F
CT Sump Temperature	32F	130F
CT Inlet Temperature	35F	130F
Compressor Current (or Power)	0	NA, Chiller dependent
Condenser Pump Current (or Power)	0	200 amps
Chilled Water Pump Current (or Power)	0	200 amps
Secondary Chilled Water Pump(s) Current (or Power)	0	200 amps
Cooling Tower Fan(s) Current (or Power)	0	200 amps
Condenser Fan(s) Current (or Power)	0	200 amps
Supply Fan(s) Current (or Power)	0	1000 amps

3.2.2.9 The administrator shall have the capability to modify the expected range of sensed data against which the data will be validated.

**The engineering units of sensed data input to the tool shall comply with the units listed in**

3.2.2.10 Table 6 for the associated physical parameter measured prior to input to the diagnostics.

**The tool shall provide the capability to convert sensed data not provided in the units listed in**



Automated Diagnostics	Version: 1.1
Software Requirements Specification	Date: 8/28/2003
Software Requirements Specification 1-1.DOC 8/29/2003	

Table 6 to the required units.

**Table 6. Required engineering units for sensed data.**

Physical Parameter	Engineering Units for Sensed Data
Temperature	Degrees F
Current	Amps

3.2.2.11 The tool shall associate with each continuous parameter one or more tolerances each corresponding to a different sensitivity level for the tool.

3.2.2.12 Any and all errors associated with obtaining, validating, converting, or storing the sensed data shall be logged as described in subsequent specifications and selected errors shall be reported to the user.

### 3.2.3 Diagnostic Process

The automated diagnostic tool shall detect and identify certain performance and operational faults in chiller and cooling tower subsystems of HVAC units following specified algorithms. In addition, the tool shall be designed to permit expansion of diagnostic analysis to additional subsystems. The faults identified and their causes and sources, shall be saved to permanent storage for subsequent analysis.

3.2.3.1 The tool shall monitor performance and operational parameters listed in Table 7 for chillers and cooling towers and identify the specific faults in the specific fault categories listed in the table.

**Table 7. Performance and Operational Parameters Monitored by the Automated Diagnostic Tool and Specific Faults Identified**

Subsystem(s)	Monitored Parameter	Fault Category	Fault
Chiller	Chilled Water Supply Temperature Maintenance	Chilled Water Supply Temperature not Maintained Correctly	The chilled water supply temperature is too high
			The chilled water supply temperature is too low
	Chiller Schedule	Chiller Schedule is Incorrect/in Error/Corrupt/Inefficient/not Followed	The chiller is on when it should be off. Energy is being wasted.

Automated Diagnostics	Version: 1.1
Software Requirements Specification	Date: 8/28/2003
Software Requirements Specification 1-1.DOC 8/29/2003	

	Compressor Cycling	Compressor Cycling is Abnormal	The compressor is cycling on too frequently. It is not staying off for the minimum required off time.
			The compressor is cycling off too frequently. It is not staying on for the minimum required on time.
	Compressor and Condenser Fan Interlock (for air-cooled condensers only)	Compressor is Improperly Interlocked with Condenser Fan	The compressor is on while the condenser fan is off. The chiller cannot reject heat and this could damage the compressor
			The condenser fan is on while the compressor is off. The fan is running unnecessarily and wasting energy.
	Compressor and Condenser Pump Interlock (for water-cooled condensers only)	Compressor is Improperly Interlocked with Condenser Pump	The compressor is on while the condenser pump is off. The chiller cannot reject heat and this could damage the compressor.
			The condenser pump is cycling unnecessarily frequently. Repeated frequent cycling will shorten the life of the condenser pump.
<b>Cooling Tower</b>	Cooling Tower Fan Cycling	Cooling Tower Fan Cycling Problem	The cooling tower fan is not staying off long enough during cycling.
			The cooling tower fan is not staying on long enough during cycling.
	Sump Temperature Control	Sump Temperature is Improperly Controlled	The cooling tower fan is off but should be on. As a result, the condenser water is not being cooled sufficiently.
			The cooling tower fan is on but it should be off. Energy is being wasted.
	Cooling Tower Approach	Cooling Tower Approach Problem	The cooling tower approach is greater than the Approach Benchmark provided in set up. Heat rejection from the cooling tower is less than expected.

Automated Diagnostics	Version: 1.1
Software Requirements Specification	Date: 8/28/2003
Software Requirements Specification 1-1.DOC 8/29/2003	

	Cooling Tower Fan Staging	Cooling Tower Fan Staging Problem	<p>The Sump temperature is above the cooling tower fan “on” set point, but all cooling tower fans are not on. This indicates a problem with the fan staging and, as a result, the cooling tower is not maintaining the sump temperature as low as it should.</p> <p>A fan is on even though the sump temperature is below the “off” set point. This indicates a fan staging problem, and energy is being wasted. All cooling tower fans should be off.</p>
	Cooling Tower Range	Cooling Tower Range Problem	The cooling tower range is below its benchmark. As result, heat rejection by the cooling tower is less than expected and the cooling tower is performing at less than its capacity.
<b>Chilled Water Loop</b>	Supply Fan(s) and the Primary-Loop Chilled Water Pumps Interlock	Supply Fan(s) and the Primary-Loop Chilled Water Pumps are not Interlocked Properly	<p>The is possibly a problem with the supply fan control.</p> <p>This chilled water pump is being operated unnecessarily and is wasting energy. The chilled water pump should not operate unless at least one of the supply fans in an air handling unit served by the chilled water pump is on.</p>
	Supply Fan(s) and the Secondary-Loop Chilled Water Pumps Interlocked	Supply Fan(s) and the Secondary-Loop Chilled Water Pumps are not Interlocked Properly.	Possible problem with secondary chilled water pump control—check to see if loads in the spaces served are being met for all supply fans that are part of air handlers served by this secondary chilled water loop and that is on when the secondary chilled water pump is off.

Automated Diagnostics	Version: 1.1
Software Requirements Specification	Date: 8/28/2003
Software Requirements Specification 1-1.DOC 8/29/2003	

			<p>The secondary chilled water pump and some of the supply fans that are served by it are not interlocked properly. This secondary chilled water pump is operating unnecessarily when all supply plans it serves are off and, as a result, is wasting energy. The secondary chilled water pump should not operate unless at least one of the supply fans in an air handler served by this pump is on.</p>
	Secondary and Primary Loop Chilled Water Pumps Interlock	Secondary and Primary Loop Chilled Water Pumps are not Interlocked Properly	<p>The secondary chilled water pumps that are on are wasting energy. Secondary chilled water pumps should only operate when the primary CHW pump is operating.</p>
<b>Chiller/Cooling Tower</b>	Cooling Tower Fan(s) and Condenser Pump Interlock	Cooling Tower Fan(s) and Condenser Pump are not Interlocked Properly	<p>The cooling tower fan and condenser pump are not interlocked properly. Energy is being wasted because the cooling tower fan should be off when the condenser pump is not operating.</p>
			<p>The interlock between the condenser pump and the cooling tower may not be properly implemented. The cooling tower fan may be off when the condenser pump is running, but this should not always be the case.</p>
<b>Chiller/Water Loop</b>	Compressor and Primary Chilled Water Pump(s) Interlock	Compressor and Primary Chilled Water Pump(s) are not Interlocked Properly	<p>The primary chilled water pumps are not interlocked properly with the compressor. The condenser pump is cycling on and off unnecessarily. Repeated frequent cycling will shorten the life of the pump.</p>
			<p>The compressor is not properly interlocked with the primary chilled water pumps. The chiller is operating without a load. Energy is being wasted and damage to the compressor may result.</p>

Automated Diagnostics	Version: 1.1
Software Requirements Specification	Date: 8/28/2003
Software Requirements Specification 1-1.DOC 8/29/2003	

			The compressor is not properly interlocked with the primary chilled water pumps. Water side economizing is not being used, and the primary chilled water pumps are cycling on too much in advance of the compressor and wasting energy.
--	--	--	---

3.2.3.2 With each fault identified in Table 7, the tool shall associate text describing the possible problem, causes, and a recommended fix. This text for each fault is listed in Table 8.

**Table 8 Text to Associate with Each Anomaly Detected**

Subsystem(s)	Fault Category	Fault/Possible Problem	Causes	Fix
Chiller	Chilled Water Supply Temperature not Maintained Correctly	The chilled water supply temperature is too high	1) Chilled water supply temperature set point is set too high. 2) Chiller load exceeds capacity.	
		The chilled water supply temperature is too low	1) Chilled water supply temperature set point is lower than necessary.	
	Chiller Schedule is Incorrect/in Error/Corrupt/Inefficient/not Followed	The chiller is on when it should be off. Energy is being wasted.	Incorrectly specified schedule.	
	Compressor Cycling is Abnormal	The compressor is cycling on too frequently. It is not staying off for the minimum required off time.	1) Incorrectly specified minimum off time in the set-up of this diagnostic, 2) Incorrectly specified minimum off time in the control algorithm for the compressor, 3) a failed relay or mis-adjusted relay, for compressors having the minimum off time controlled by a relay.	

Automated Diagnostics	Version: 1.1
Software Requirements Specification	Date: 8/28/2003
Software Requirements Specification 1-1.DOC 8/29/2003	

		The compressor is cycling off too frequently. It is not staying on for the minimum required on time.	1) Incorrectly specified minimum on time in the set-up of this diagnostic, 2) Incorrectly specified minimum off time in the control algorithm for the compressor, 3) a failed relay or mis-adjusted relay, for compressors having the minimum on time controlled by a relay.	
Compressor is Improperly Interlocked with Condenser Fan (for air-cooled condensers only)		The compressor is on while the condenser fan is off. The chiller cannot reject heat and this could damage the compressor	The compressor is on while the condenser fan is off. The interlock between the compressor and condenser fan in the control code is not specified correctly or is overridden.	
		The condenser fan is on while the compressor is off. The fan is running unnecessarily and wasting energy.	The condenser fan is running while the compressor is off. This wastes energy. The interlock between the compressor and condenser fan in the control code is not specified correctly or is overridden.	
Compressor is Improperly Interlocked with Condenser Pump (for water-cooled condensers only)		The compressor is on while the condenser pump is off. The chiller cannot reject heat and this could damage the compressor.	The compressor is on while the condenser pump is off. The interlock between the compressor and condenser pump in the control code is not specified correctly or is overridden.	

Automated Diagnostics	Version: 1.1
Software Requirements Specification	Date: 8/28/2003
Software Requirements Specification 1-1.DOC 8/29/2003	

		The condenser pump is cycling unnecessarily frequently. Repeated frequent cycling will shorten the life of the condenser pump.	The Condenser Pump is turning on and off too frequently.	
		The condenser pump is turning on too much in advance of the compressor and wasting energy.	The Condenser Pump Maximum Start-Up time is not specified correctly or is overridden in the control code.	
<b>Cooling Tower</b>	Cooling Tower Fan Cycling Problem	The cooling tower fan is not staying off long enough during cycling.	1) The timer that is intended to eliminate short cycling is not working. 2) The "on" and "off" control set points for the cooling tower fan are too close to one another.	
		The cooling tower fan is not staying on long enough during cycling.	1) The timer that is supposed to eliminate short cycling is not working properly. 2) The "on" and "off" control set points for the fan are too close to one another. 3) The cooling tower capacity is too great for the load, so the fans rapidly cycle off (i.e., the on time is very short) because the load is met quickly.	
	Sump Temperature is Improperly Controlled	The cooling tower fan is off but should be on. As a result, the condenser water is not being cooled sufficiently.	1) a cooling tower control problem, 2) sump temperature sensor problem, 3) electrical problems such as a motor failure, 4) other problems with the fan motor.	

Automated Diagnostics	Version: 1.1
Software Requirements Specification	Date: 8/28/2003
Software Requirements Specification 1-1.DOC 8/29/2003	

		The cooling tower fan is on but it should be off. Energy is being wasted.	1) a cooling tower control problem, 2) an actuator or relay has failed.	
	Cooling Tower Approach Problem	The cooling tower approach is greater than the Approach Benchmark provided in set up. Heat rejection from the cooling tower is less than expected.	1) The cooling tower media is fouled due to mineral deposits or ambient dirt, dust, or other contaminants. 2) Restricted airflow for other reasons (e.g., piece of cardboard stuck over part of cooling tower air inlet). 3) There is condenser pump fouling, pipe fouling, or other restrictions on the water side.	
	Cooling Tower Fan Staging Problem	The Sump temperature is above the cooling tower fan "on" set point, but all cooling tower fans are not on. This indicates a problem with the fan staging and, as a result, the cooling tower is not maintaining the sump temperature as low as it should.	1) Different values of the fan "on" set point are specified in the fan controller and this software. 2) Fan staging control algorithm is not correctly specified. 3) A fan motor or electrical connection has failed. 4) The sump temperature sensor has failed or is out of calibration.	
		A fan is on even though the sump temperature is below the "off" set point. This indicates a fan staging problem, and energy is being wasted. All cooling tower fans should be off.	1) Different values of the fan "off" set point are specified in the fan controller and this software. 2) Fan staging control algorithm is not correctly specified. 3) The sump temperature sensor has failed or is out of calibration.	



Automated Diagnostics	Version: 1.1
Software Requirements Specification	Date: 8/28/2003
Software Requirements Specification 1-1.DOC 8/29/2003	

	Cooling Tower Range Problem	The cooling tower range is below its benchmark. As result, heat rejection by the cooling tower is less than expected and the cooling tower is performing at less than its capacity.	1) Tower media may be fouled due to mineral deposits or ambient dirt, dust, or other contaminants. 2) the airflow is restricted by some other obstruction. 3) The condenser pump is fouling, pipes are fouling, or there are other water-side flow restrictions. 4) The cooling tower is too small for the load (i.e., there is a design problem)	
<b>Chilled Water Loop</b>	Supply Fan(s) and the Primary-Loop Chilled Water Pumps are not Interlocked Properly	The is possibly a problem with the supply fan control.	The chilled water pump is off and the supply fan for at least one air handler served by this pump is on. There may be a problem with the control of this supply fan or other parts of the air handlers with supply fans operating under these conditions.	
		This chilled water pump is being operated unnecessarily and is wasting energy. The chilled water pump should not operate unless at least one of the supply fans in an air handling unit served by the chilled water pump is on.	Improper interlock between the chilled water pump and the supply fans.	

Automated Diagnostics	Version: 1.1
Software Requirements Specification	Date: 8/28/2003
Software Requirements Specification 1-1.DOC 8/29/2003	

	Supply Fan(s) and the Secondary-Loop Chilled Water Pumps are not Interlocked Properly.	Possible problem with secondary chilled water pump control—check to see if loads in the spaces served are being met for all supply fans that are part of air handlers served by this secondary chilled water loop and that is on when the secondary chilled water pump is off.	Improper interlock between the secondary chilled water pump and the supply fans of air handlers it serves.	
		The secondary chilled water pump and some of the supply fans that are served by it are not interlocked properly. This secondary chilled water pump is operating unnecessarily when all supply plans it serves are off and, as a result, is wasting energy. The secondary chilled water pump should not operate unless at least one of the supply fans in an air handler served by this pump is on.	Improper interlock between the secondary chilled water pump and the supply fans of air handlers it serves.	
	Secondary and Primary Loop Chilled Water Pumps are not Interlocked Properly	The secondary chilled water pumps that are on are wasting energy. Secondary chilled water pumps should only operate when the primary CHW pump is operating.	Improper interlock between the secondary chilled water pump and the supply fans of air handlers it serves.	
<b>Chiller/Cooling Tower</b>	Cooling Tower Fan(s) and Condenser Pump are not Interlocked Properly	The cooling tower fan and condenser pump are not interlocked properly. Energy is being wasted because the cooling tower fan should be off when the condenser pump is not operating.	The cooling tower fan and condenser pump are not interlocked properly.	

Automated Diagnostics	Version: 1.1
Software Requirements Specification	Date: 8/28/2003
Software Requirements Specification 1-1.DOC 8/29/2003	

		The interlock between the condenser pump and the cooling tower may not be properly implemented. The cooling tower fan may be off when the condenser pump is running, but this should not always be the case.	The cooling tower fan and condenser pump may not be interlocked properly.	
<b>Chiller/Water Loop</b>	Compressor and Primary Chilled Water Pump(s) are not Interlocked Properly	The primary chilled water pumps are not interlocked properly with the compressor. The condenser pump is cycling on and off unnecessarily. Repeated frequent cycling will shorten the life of the pump.	The chilled water pump is cycling between on and off while the compressor is off. The primary chilled water pumps are not interlocked properly with the compressor.	
		The compressor is not properly interlocked with the primary chilled water pumps. The chiller is operating without a load. Energy is being wasted and damage to the compressor may result.	The compressor is running while the primary chilled water pumps are not operating because the compressor is not properly interlocked with the primary chilled water pumps.	
		The compressor is not properly interlocked with the primary chilled water pumps. Water side economizing is not being used, and the primary chilled water pumps are cycling on too much in advance of the compressor and wasting energy.	The primary chilled water pumps are cycling on too much in advance of the compressor turning on.	

3.2.3.3 The tool shall be designed to permit the addition of diagnostic algorithms for other subsystems of HVAC units.

3.2.3.4 A diagnostic algorithm shall not process if any input data to the algorithm is missing. The user shall be notified if a diagnostic algorithm cannot process due to missing data.

Automated Diagnostics	Version: 1.1
Software Requirements Specification	Date: 8/28/2003
Software Requirements Specification 1-1.DOC 8/29/2003	

3.2.3.5 Any and all errors associated with failures of the diagnostic algorithms shall be logged as described in subsequent specifications and selected errors shall be reported to the user.

3.2.3.6 The tool shall monitor the unit under diagnosis, either in real time or batch mode, for an indefinite period of time or until input data are no longer available, and log diagnostic results as they are determined.

3.2.3.7 Diagnostic results that are saved to permanent storage shall be accompanied in storage by the absolute time of occurrence, the identity of the unit to which the diagnostic applies, and the identity of the diagnostic.

3.2.3.8 The administrator user shall have the capability to adjust the sensitivity of the diagnostic analysis in order to increase or decrease the probability of fault detection.

#### 3.2.4 *Output Processing*

The automated diagnostic tool shall display and record diagnostic results. Diagnostic results to be displayed to the user will be done so in a simple, graphical and textual format. Diagnostic results shall also be saved to permanent storage for subsequent retrieval, display, and analysis.

3.2.4.1 The administrator shall have the ability to specify which diagnostic results will not be reported in any manner, i.e., not detected.

3.2.4.2 The display of each diagnostic result for fault conditions will include a description of the fault, potential causes of the fault, the location of the fault, and the absolute time of occurrence.

### 3.3 **Usability**

This section describes requirements related to the usability of the tool.

#### 3.3.1 *User Interface*

The following specifies usability requirements for the user interface.

Automated Diagnostics	Version: 1.1
Software Requirements Specification	Date: 8/28/2003
Software Requirements Specification 1-1.DOC 8/29/2003	

3.3.1.1 The area on the main, systems, and condition windows sensitive to the users selection device, typically the mouse, shall include the line surrounding the item of interest over the entire width of the window. This includes the diagnostic indicators.

3.3.1.2 The windows listing diagnostic results shall increase in height as needed to display entries up to a maximum of ten entries. Once the window has reached maximum size and there are additional items to display, the window shall deploy a scroll bar to permit the user to scroll through the additional entries. In this event, a summary set of diagnostic indicators shall appear above (below) the top (bottom) entry in the display. This set(s) of indicators shall summarize diagnostic indicators not currently appearing on the list above (below) it. An indicator in the summary set shall be active if any similar indicator not appearing above (or below) it is active. The summary set indicators comply with the same specification for activation as other indicators (see 3.5.1.39).

3.3.1.3 The building, subsystems, and condition windows shall display the current time if the diagnostic tool is operating in real time. If the tool is operating in batch mode, the time displayed will be the time associated with the entry currently being processed in the batched input.

3.3.1.4 If only a single building is defined, the subsystems window shall become the main window of the application and shall have all the functionality of the main window as described in these specifications.

3.3.1.5 Each window of the diagnostic tool shall display an animated graphical feature indicating the status, whether active or not, of the diagnostic processing.

3.3.1.6 The subsystem window shall be modal to the building window, the condition window modal to the subsystem window, and the diagnostic history and diagnostic information windows shall be modal to the condition window.

### **3.4 Supportability**

This section describes requirements related to the support of the software after initial installation.

#### **3.4.1 Error Reporting**

Significant errors in software operation shall be logged to permanent storage with sufficient detail to guide the administrator and to assist support staff in locating and rectifying the error. In addition, selected errors shall be reported to the user.

3.4.1.1 Software errors logged to permanent storage shall include the absolute time of occurrence, the name of the software module in which the error occurred, the name of the software function in which the error occurred, and a description of the error.

### **3.5 Interfaces**

This section describes requirements related to interfaces of the tool.

#### **3.5.1 User Interfaces**

This section describes the specifications for the user interface.

3.5.1.1 The user interface shall consist of six windows: Main window, configuration window, subsystems window, condition window, diagnostic information window, and diagnostic history window.

3.5.1.2 These windows shall be organized in a hierarchy enforcing a navigational order on the user. This hierarchy is depicted in Figure 4. As indicated in the figure, the main window is at the top of the hierarchy

Automated Diagnostics	Version: 1.1
Software Requirements Specification	Date: 8/28/2003
Software Requirements Specification 1-1.DOC 8/29/2003	

and is the first window that appears when the tool begins execution. The configuration window is subordinate to the main window and can only be displayed by a user selection on the main window. The third window in the hierarchy is the subsystems window and it can only be displayed by a user selection on the main window. The fourth window in the hierarchy is the condition window and it can only be displayed by a user selection on the subsystems window. The fifth window is the diagnostic information window. This window can only be displayed by a user selection on the condition window or by a user selection on the diagnostic history window if it is displayed. The diagnostic history window can only be displayed by a user action on the diagnostic information window.

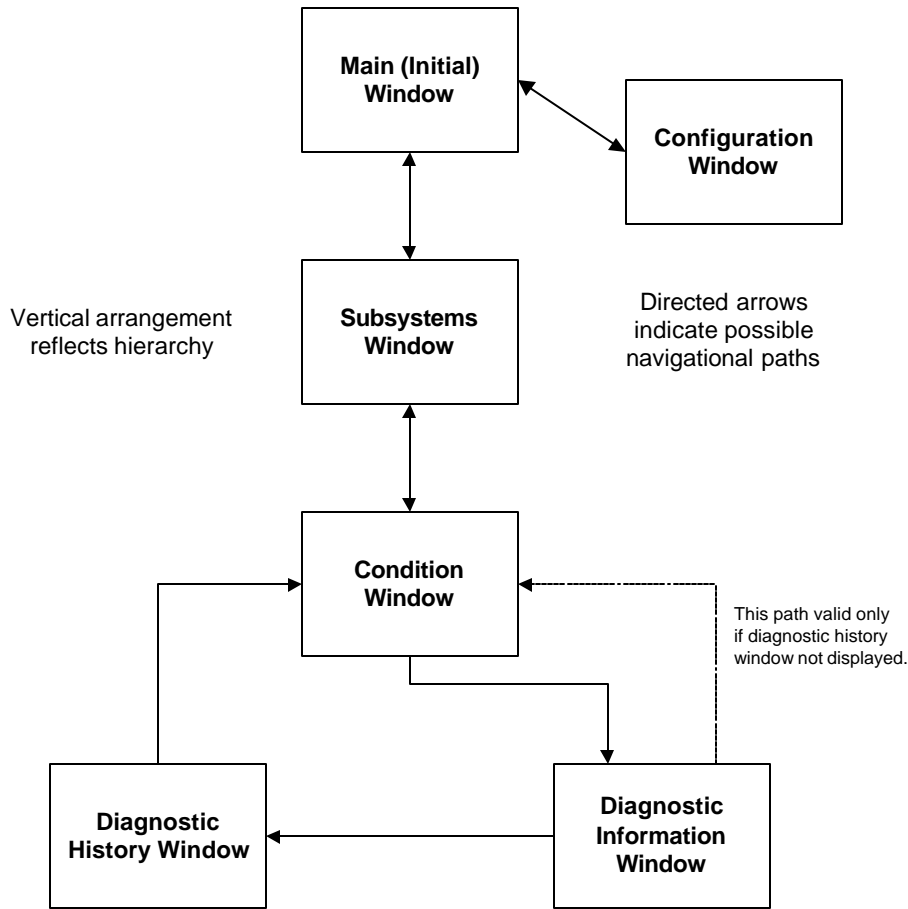

**Figure 4 User Interface Window Hierarchy**

3.5.1.3 The main (e.g., initial or default) window shall list buildings monitored and summarizing the current diagnostic status of all contained monitored units. A recommended layout for this window is presented in Figure 5. This window shall be titled "Diagnostician".

Automated Diagnostics	Version: 1.1
Software Requirements Specification	Date: 8/28/2003
Software Requirements Specification 1-1.DOC 8/29/2003	

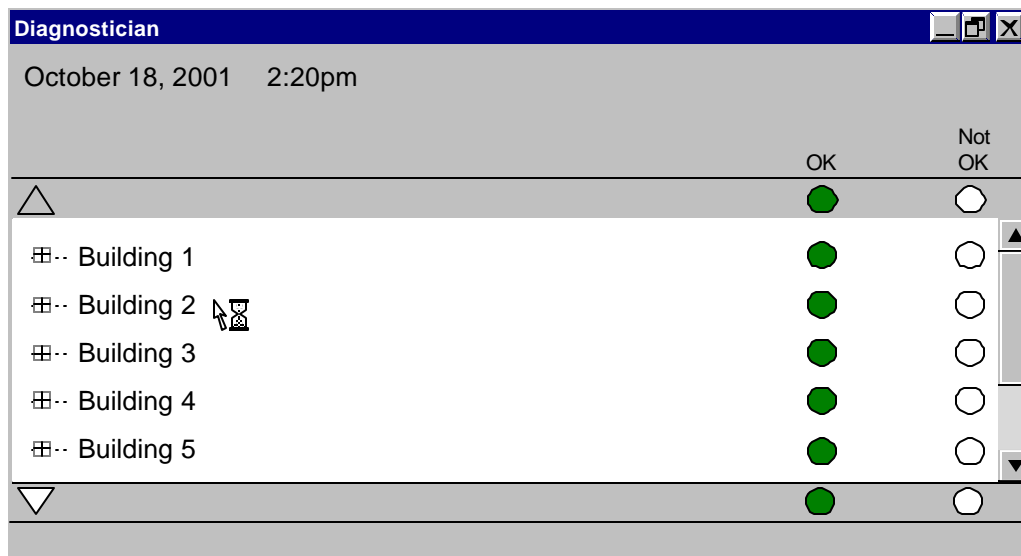

**Figure 5 Recommended Layout for Main Window**

3.5.1.4 The main window shall have main menus entitled “File” and “Status”.

3.5.1.5 The main menu entitled “File” shall contain the following menu items in the following order: “Configure Diagnostics”, “Logout”, “Exit”.

3.5.1.6 The main menu entitled “Status” shall contain the following menu items in the following order: “Start Diagnostics”, “Stop Diagnostics”.

3.5.1.7 The menu items named “Configure Diagnostics” and “Exit” in the main menu entitled “File” shall be enabled at all times.

3.5.1.8 The menu item named “Logout” in the main menu entitled “File” shall be enabled only if the current user is presently authenticated as the administrator user. Otherwise, this menu item shall be disabled.

3.5.1.9 The menu item named “Start Diagnostics” in the main menu entitled “Status” shall be enabled only if diagnostic processing is not currently running. Otherwise, the menu item shall be disabled.

3.5.1.10 The menu item named “Stop Diagnostics” in the main menu entitled “Status” shall be enabled only if diagnostic processing is currently running. Otherwise, the menu item shall be disabled.

3.5.1.11 Selecting the “Configure Diagnostics” menu item of the main menu entitled “File” shall display the configuration window, making it the current window, modal to the main window.

- 3.5.1.12 The configuration window shall permit the administrator user to modify the following parameters:
- The password for the administrator user.
  - A toggle enabling or disabling the main window of the tool as a screen saver.
  - A toggle enabling or disabling the main window’s position on the screen as the top most window.
  - Buildings and subsystems to be monitored and the conditions they will be monitored

Automated Diagnostics	Version: 1.1
Software Requirements Specification	Date: 8/28/2003
Software Requirements Specification 1-1.DOC 8/29/2003	

- for. The conditions will be selected from a list provided by the tool.
- e. The enabled state of individual conditions. Disabled conditions will not be processed or displayed.
- f. The sensitivity of each condition by selecting a sensitivity from a list provided by the tool.
- g. Scale factors for transforming the engineering units of sensed input data to the required units.
- h. The expected range of sensed input data.

3.5.1.13 The configuration window shall display the following non-modifiable information:

a.

3.5.1.14 The configuration window shall have a button labeled "Save" that when clicked will present the user with a window by which to enter a disk file or database name in which to save the modifiable data in the window. Entering a file name shall cause the permanent storage of the modified parameters and their immediate use by the diagnostic operations after confirmatory responses by the user. If the user does not confirm the request to save, it will not be performed. If the user does not confirm the request to relay the modified parameters to the diagnostic processing immediately, it will not be performed. In either event, the configuration window will remain displayed.

3.5.1.15 The configuration window shall have a button labeled "Close" that will dismiss the configuration window and return the user to the main window. If the user has made changes to data in the configuration window, the tool will request confirmation of the user's desire to dismiss the window. If the user does not confirm the request, the window will not be dismissed.

3.5.1.16 The configuration window shall have a button labeled "Recall" that will permit the user to recall a disk file of previously saved parameters from which to populate the configuration window. When functioning as a screen saver, the window shall change location on the screen periodically and will continue to be updated by diagnostic results.

3.5.1.17 The subsystems window shall list subsystems monitored for a specific building and summarizing the current diagnostic status of all monitored subsystems. A recommended layout for this window is presented in Figure 6.

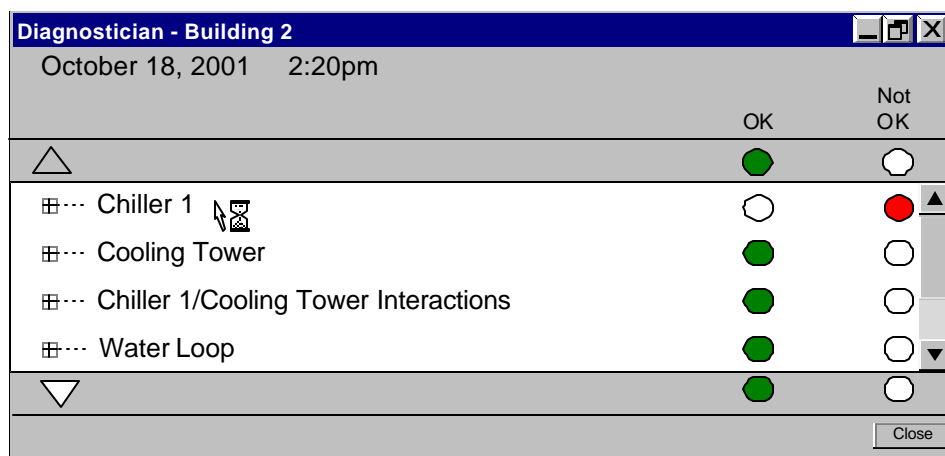

Figure 6 Recommended Layout for Systems Window



Automated Diagnostics	Version: 1.1
Software Requirements Specification	Date: 8/28/2003
Software Requirements Specification 1-1.DOC 8/29/2003	

3.5.1.18 The condition window shall list the current status of all diagnostics for a specific subsystem. A recommended layout for this window is depicted in Figure 7.

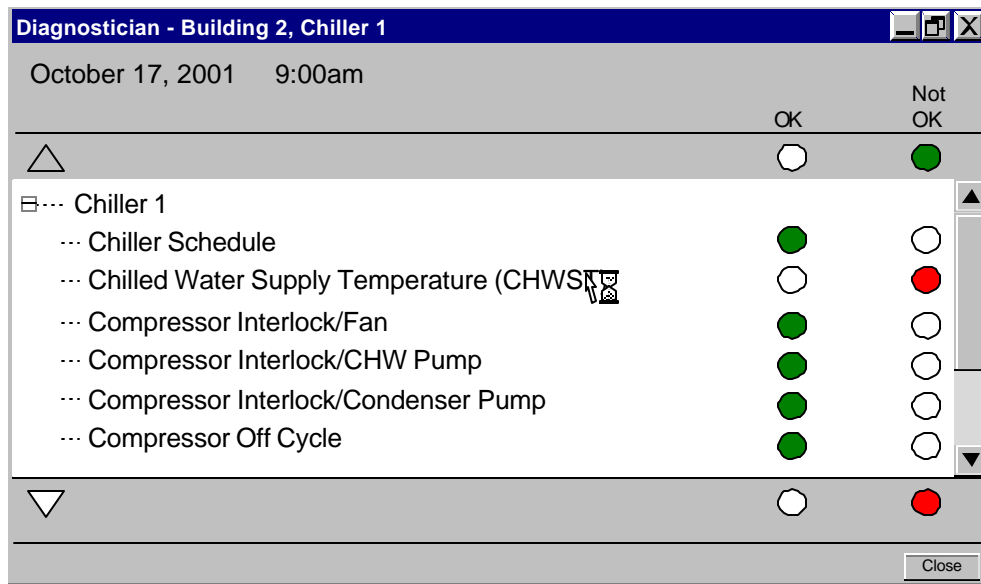

Figure 7 Recommended Layout for Condition Window

3.5.1.19 The diagnostic information window shall provide a detailed description of the diagnostic. A recommended layout for this window is depicted in Figure 8.

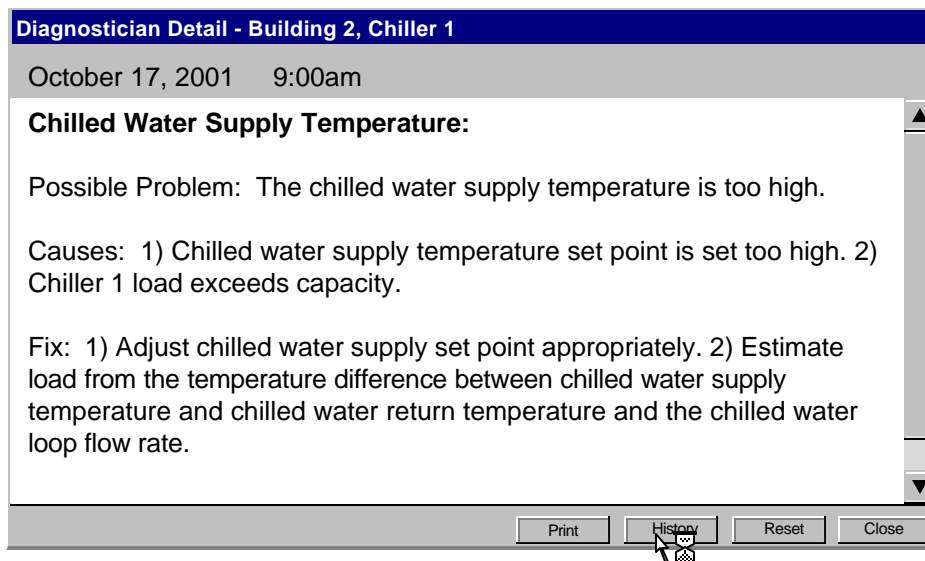

Figure 8 Recommended Layout for Diagnostic Information Window

Automated Diagnostics	Version: 1.1
Software Requirements Specification	Date: 8/28/2003
Software Requirements Specification 1-1.DOC 8/29/2003	

3.5.1.20 The diagnostic information window shall have a button labeled “Print” that when clicked will display a window listing items to print including the diagnostic information window, the history window, and both the diagnostic and history windows. The user selects the item of interest and clicks the “OK” button to print the selection, an image(s) of the item(s) selected.

3.5.1.21 The diagnostic information window shall include the following information regarding the diagnostic:

1. A description of the possible problem.
2. Potential causes.
3. Fixes.

3.5.1.22 The diagnostic information window shall have a button labeled “Close” that shall dismiss the window.

3.5.1.23 The diagnostic information window shall have a button labeled “History” that when clicked will display the diagnostic history window and display the previous week’s diagnostic results.

3.5.1.24 The diagnostic history window shall display historical diagnostic results for a specific diagnostic. A recommended layout for this window is depicted in **Error! Reference source not found.** This figure includes a color map that provides a graphical indication of diagnostic condition.

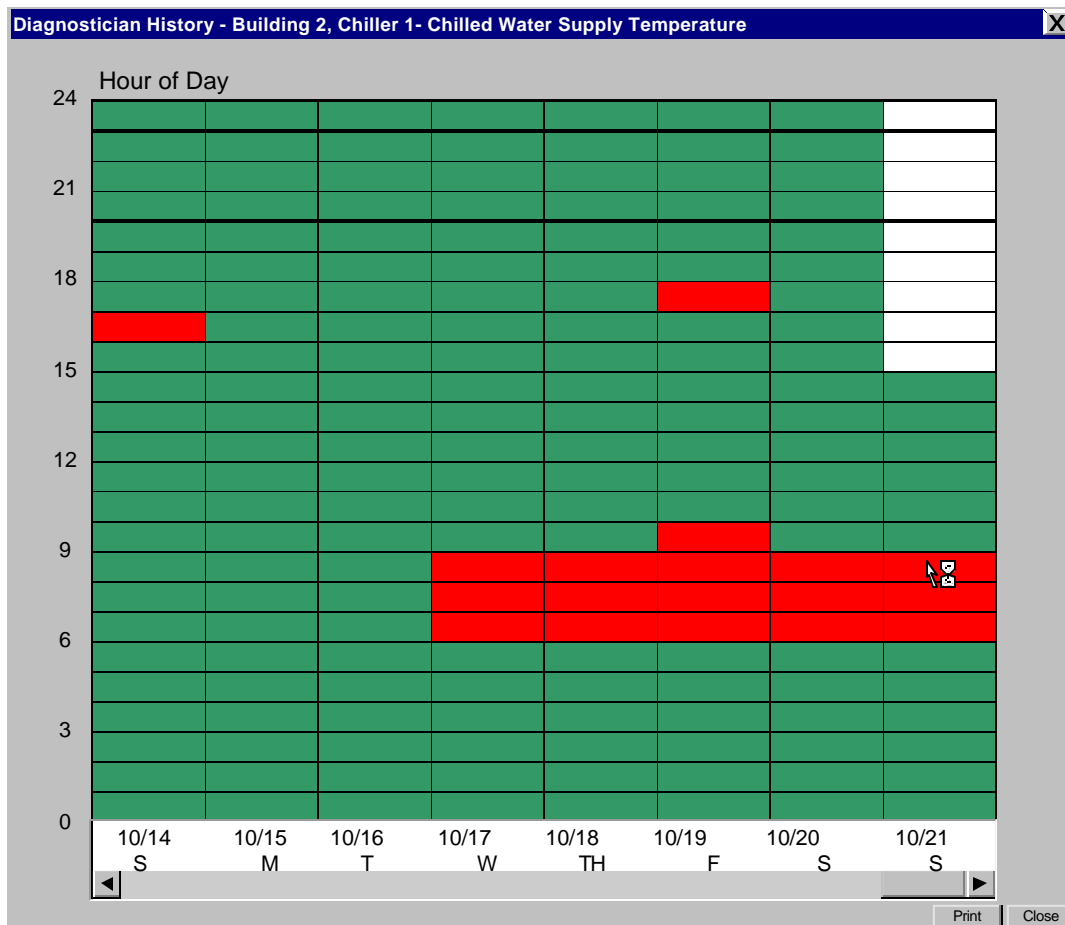

Figure 9 Recommended Layout for Diagnostic History Window

Automated Diagnostics	Version: 1.1
Software Requirements Specification	Date: 8/28/2003
Software Requirements Specification 1-1.DOC 8/29/2003	

- 3.5.1.25 The diagnostic history window shall provide user selections for start times and end times for the history interval. These selections shall be in the form of a calendar control.
- 3.5.1.26 The smallest time interval displayed by the diagnostic history window is one week.
- 3.5.1.27 The longest time interval that may be displayed by the diagnostic history window is two years.
- 3.5.1.28 The color map of the history window shall indicate confirmed faults with the color red, potential faults with the color yellow, normal conditions with the color green, and periods when diagnostic processing was not active with the color gray. Diagnostic processing should be assumed inactive between periods of time when no confirmed fault, potential fault, or normal condition has been recorded.
- 3.5.1.29 The vertical axis of the color map of the history window shall indicate hour of the day and the horizontal axis shall indicate the absolute date and the day of week.
- 3.5.1.30 The diagnostic history window shall have a button labeled "Print" that when clicked will display a window listing items to print including the diagnostic information window, the history window, and both the diagnostic and history windows. The user selects the item of interest and clicks the "OK" button to print the selection, an image(s) of the item(s) selected.
- 3.5.1.31 The diagnostic history window shall have a button labeled "Close" that will dismiss the window.
- 3.5.1.32 The subsystems window, condition window, and diagnostic information window shall display a title that indicates its specific location or absolute path in the navigation hierarchy of windows. This title shall be a concatenation of the title of the previous window displayed, not including the diagnostic history window, and the name of the entry selected to obtain the current window. The two parts of the title shall be separated by a dash surrounded by a single space.
- 3.5.1.33 The main window, subsystems window, condition window, and diagnostic information window shall display the appropriate time below the title as specified in 3.3.1.3.
- 3.5.1.34 The main window, subsystems window, and condition window shall have three diagnostic indicators for each item listed.
- 3.5.1.35 One indicator shall be active when no diagnostic conditions exists. This indicator shall be designated the "OK" indicator and shall appear green when active.
- 3.5.1.36 One indicator shall be active when a potential diagnostic condition exists. This indicator shall be designated the "Caution" and shall appear yellow when active.
- 3.5.1.37 One indicator shall be active when a confirmed diagnostic condition exists. This indicator shall be designated the "Not OK" indicator and shall appear red when active.
- 3.5.1.38 Only one indicator shall be active at a given time for a specific diagnostic and no indicators shall flash when active.
- 3.5.1.39 The diagnostic indicators on the main window and subsystems window shall summarize all diagnostic conditions associated with each entry in the window. In general, an active "OK" indicator indicates no positive diagnostic results currently exist within the building or subsystem, as applicable for the window. An active "Caution" indicator indicates that at least one potential problem currently exists within the building or subsystem, as applicable, and no confirmed problem currently exists. An active "Not OK" indicator indicates at least one confirmed problem exists regardless of whether cautionary or

Automated Diagnostics	Version: 1.1
Software Requirements Specification	Date: 8/28/2003
Software Requirements Specification 1-1.DOC 8/29/2003	

non-positive results exist. Essentially, confirmed problems override potential problem indications which override non-positive results.

### **3.6 Security**

Certain functions of the tool directly available to the user require the user to possess supplementary privileges associated with performing these functions. These supplementary privileges are possessed by the administrator user and are in addition to those of the general user as described in 2.5. The tool determines the type of user by requesting an identifier and password from the user. The requirements related to this process are discussed in other requirements in this document.

### **3.7 Other Requirements**

The tool shall log to permanent storage the occurrence of changes to the fixed data. The log shall indicate the time and date of the change, original value of the item(s) changed, and the new value of the item(s) changed.

Automated Diagnostics	Version: 1.1
Software Requirements Specification	Date: 8/28/2003
Software Requirements Specification 1-1.DOC 8/29/2003	

4. **Appendix A: Data Flow Diagrams of Diagnostic Processes for Chillers, Cooling Towers, and Chilled-Water Distribution**

Automated Diagnostics	Version: 1.1
Software Requirements Specification	Date: 8/28/2003
Software Requirements Specification 1-1.DOC 8/29/2003	

## Context Diagram Diagnose Chiller/Cooling Tower

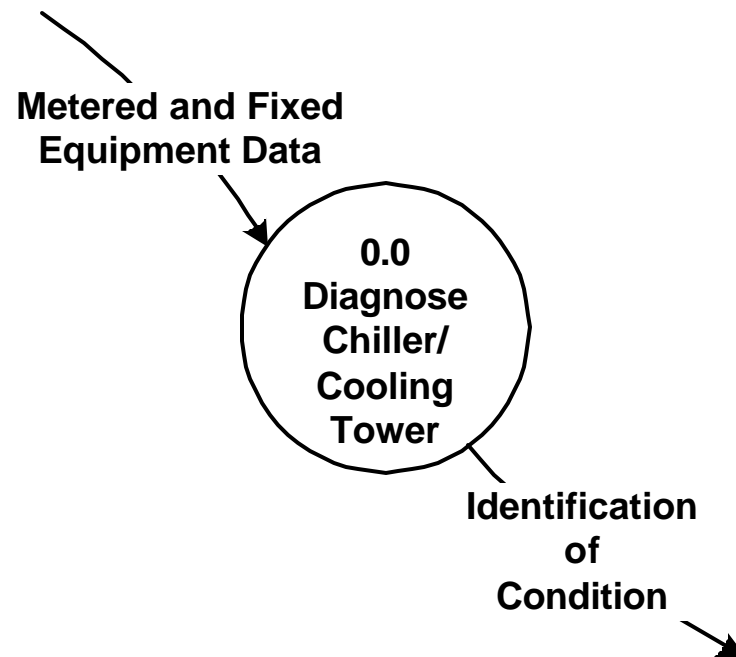

Automated Diagnostics	Version: 1.1
Software Requirements Specification	Date: 8/28/2003
Software Requirements Specification 1-1.DOC 8/29/2003	

## 0.0 Diagnose Chiller/Cooling Tower

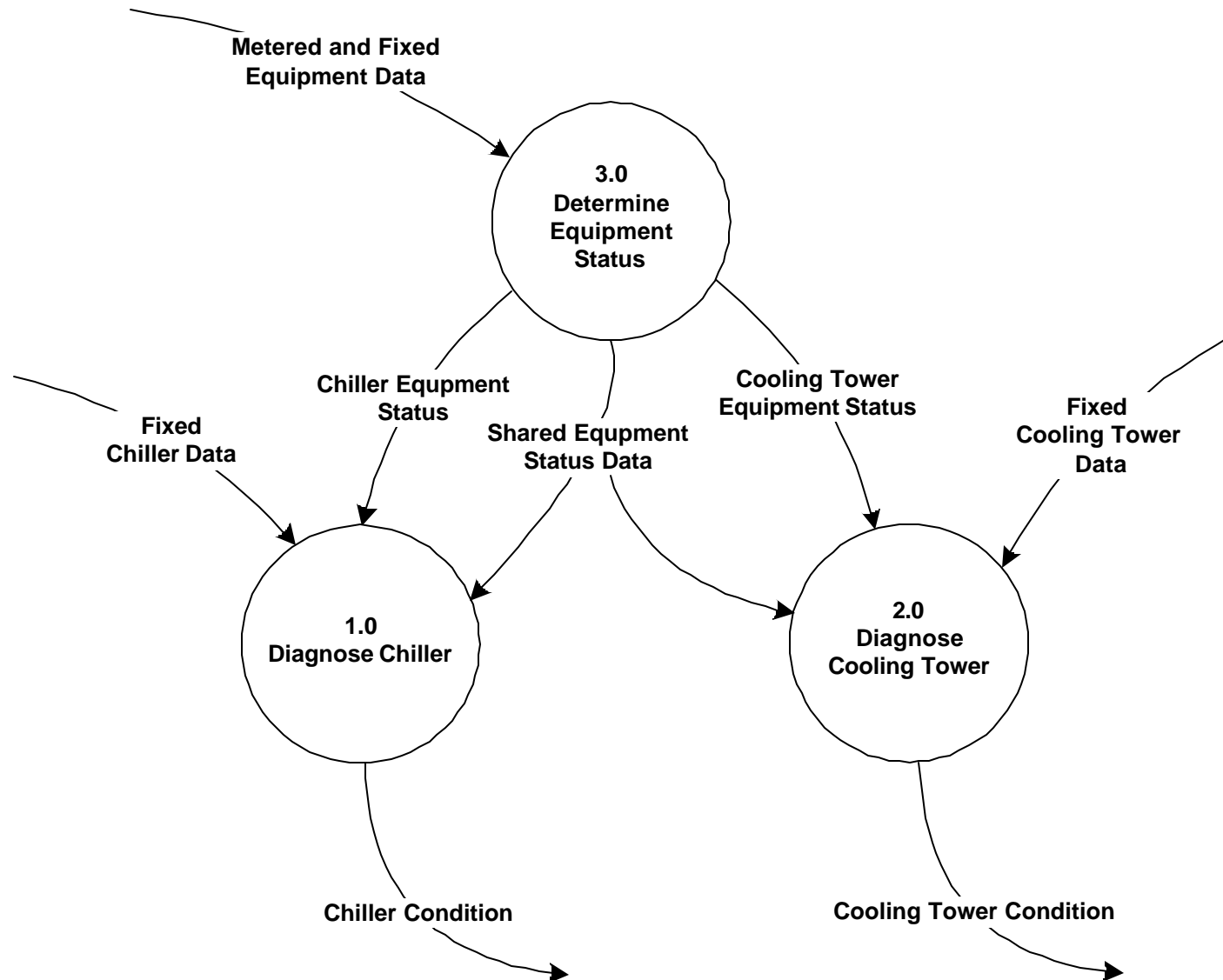

Automated Diagnostics	Version: 1.1
Software Requirements Specification	Date: 8/28/2003
Software Requirements Specification 1-1.DOC 8/29/2003	

# 0.0 Diagnose Chiller/Cooling Tower

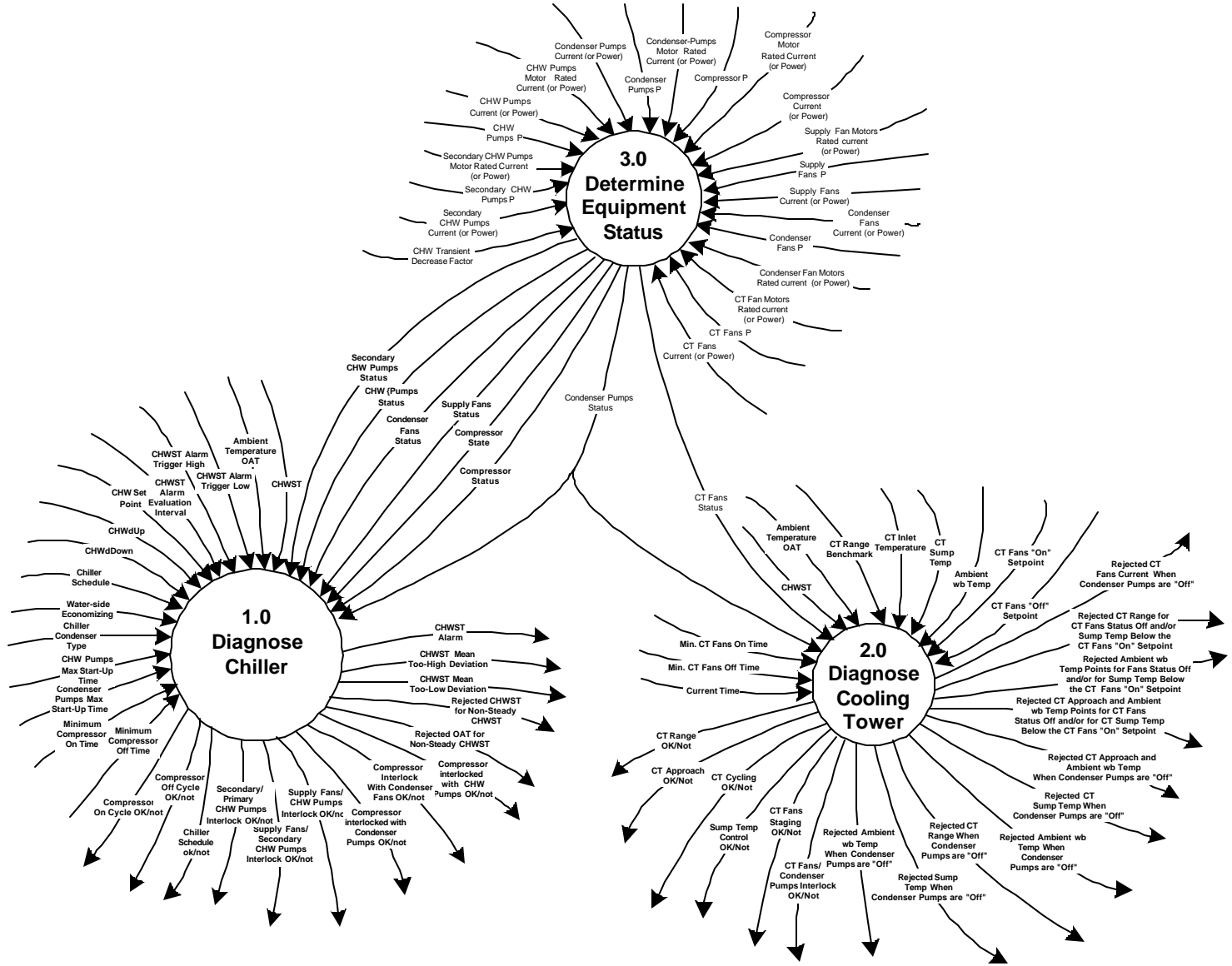



Automated Diagnostics	Version: 1.1
Software Requirements Specification	Date: 8/28/2003
Software Requirements Specification 1-1.DOC 8/29/2003	

## 1.0 Diagnose Chiller

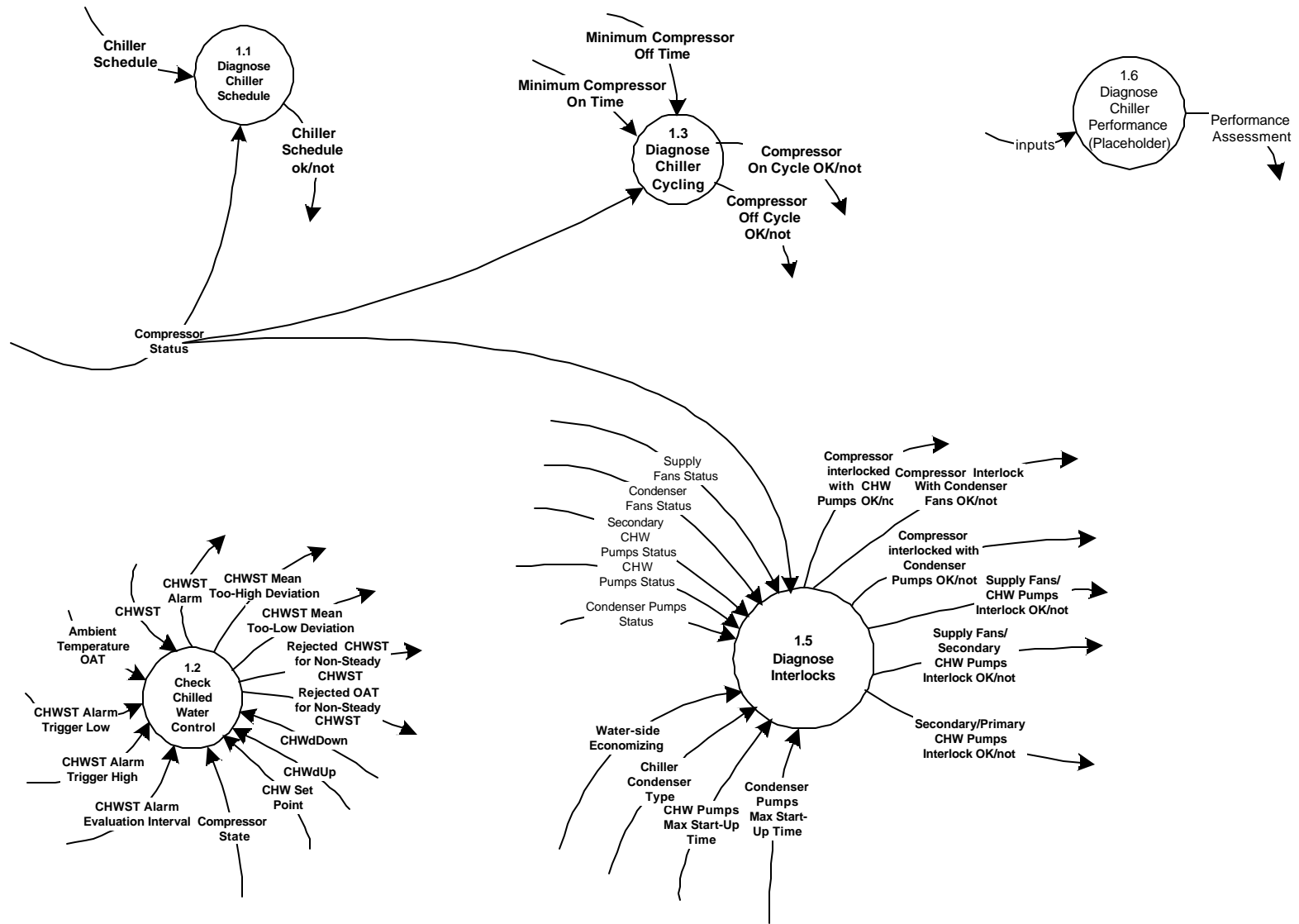

Automated Diagnostics	Version: 1.1
Software Requirements Specification	Date: 8/28/2003
Software Requirements Specification 1-1.DOC 8/29/2003	

## 1.1 Diagnose Chiller Schedule

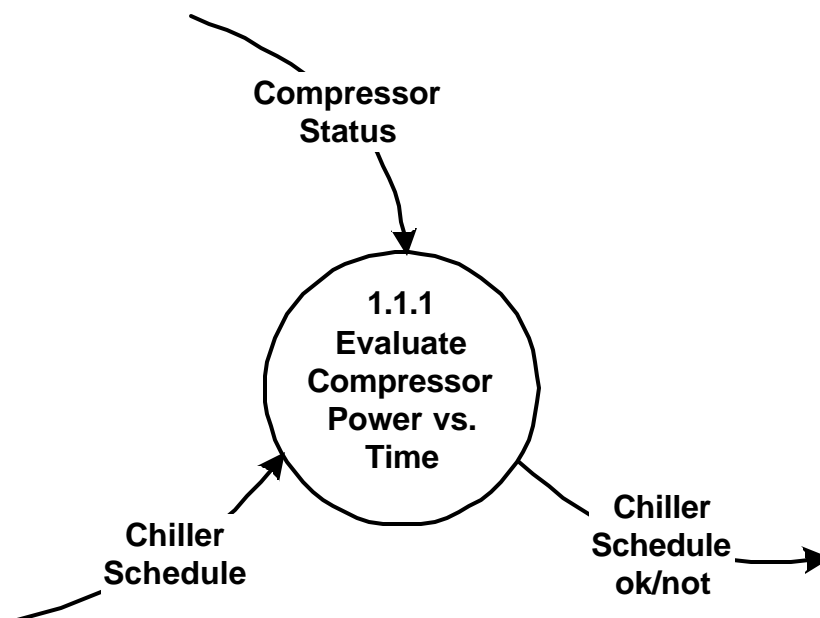

Automated Diagnostics	Version: 1.1
Software Requirements Specification	Date: 8/28/2003
Software Requirements Specification 1-1.DOC 8/29/2003	

### 1.1.1 Evaluate Compressor Power vs. Time

Compare the current time to the scheduled time for the chiller to be on.,  
If the current time is a scheduled chiller "on" time, then stop--make no further check. OK.  
If the current time is outside the scheduled chiller "on" times (i.e., the chiller should be off),  
then check if the Compressor Status = "Off."  
If the Compressor Status = "Off," then the chiller is off as it should be and it is OK.  
Set Chiller Schedule OK/Not = "OK".  
If the Compressor Status = "On," then the Chiller is "On" when it should be off. Not  
OK. Energy is being wasted. Set Chiller Schedule OK/Not = "Not OK"

Note: The purpose of this process is to determine if the chiller is on when it is supposed to be off.

Ref. File: 1.2 Chiller schedule diagnostics.doc

Automated Diagnostics	Version: 1.1
Software Requirements Specification	Date: 8/28/2003
Software Requirements Specification 1-1.DOC 8/29/2003	

## 1.2 Check Chilled Water Control

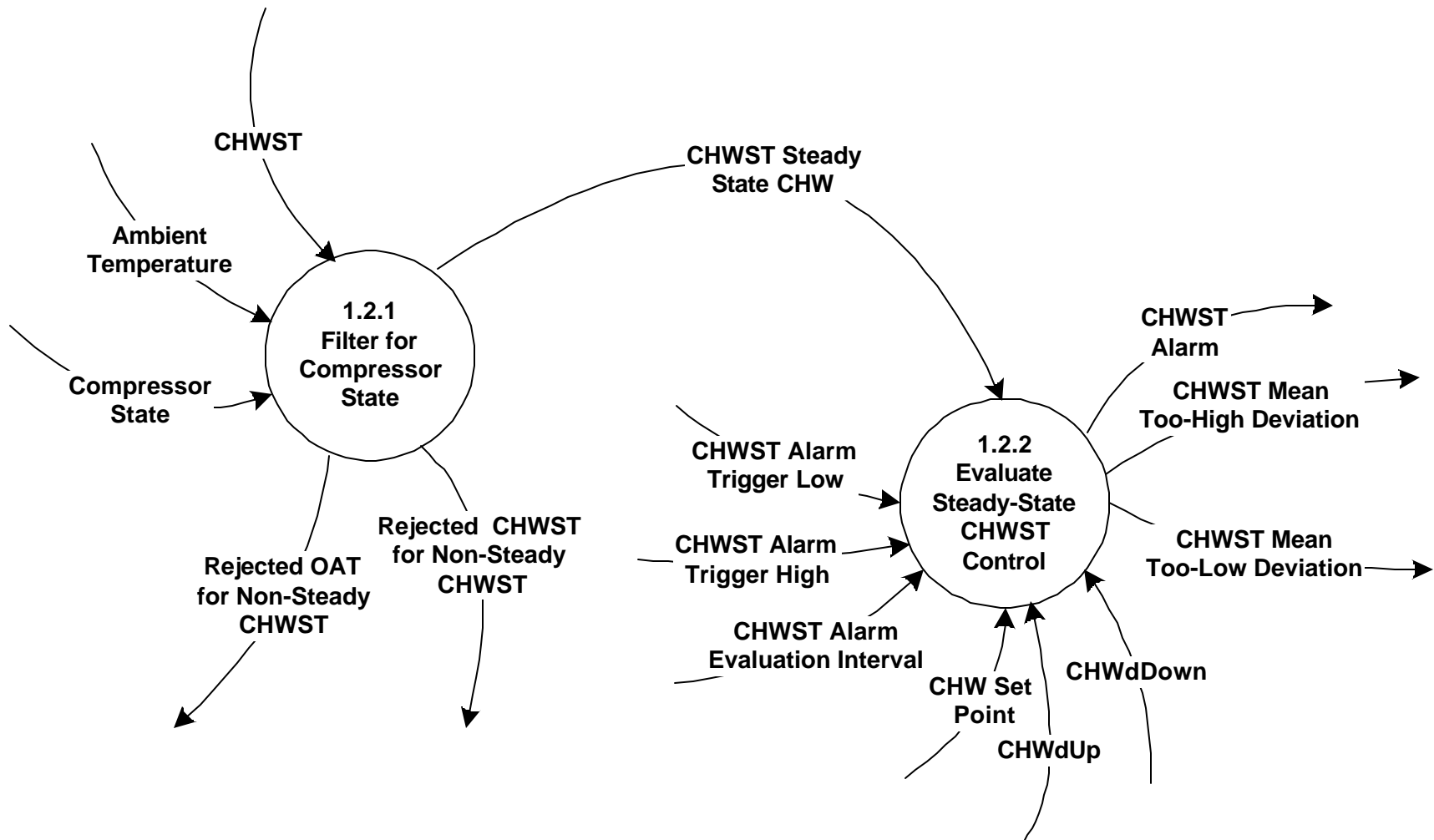

Automated Diagnostics	Version: 1.1
Software Requirements Specification	Date: 8/28/2003
Software Requirements Specification 1-1.DOC 8/29/2003	

## 1.2.1 Filter (pass) CHWST Steady State "On" Only

If Compressor State = "Steady", then pass values of CHWST.  
Label these passed values CHWST Steady State CHW.

If Compressor State = "Transient" or Compressor State = "Off", then  
reject values of CHWST.

Automated Diagnostics	Version: 1.1
Software Requirements Specification	Date: 8/28/2003
Software Requirements Specification 1-1.DOC 8/29/2003	

## 1.2.2 Evaluate Steady-State CHWST Control

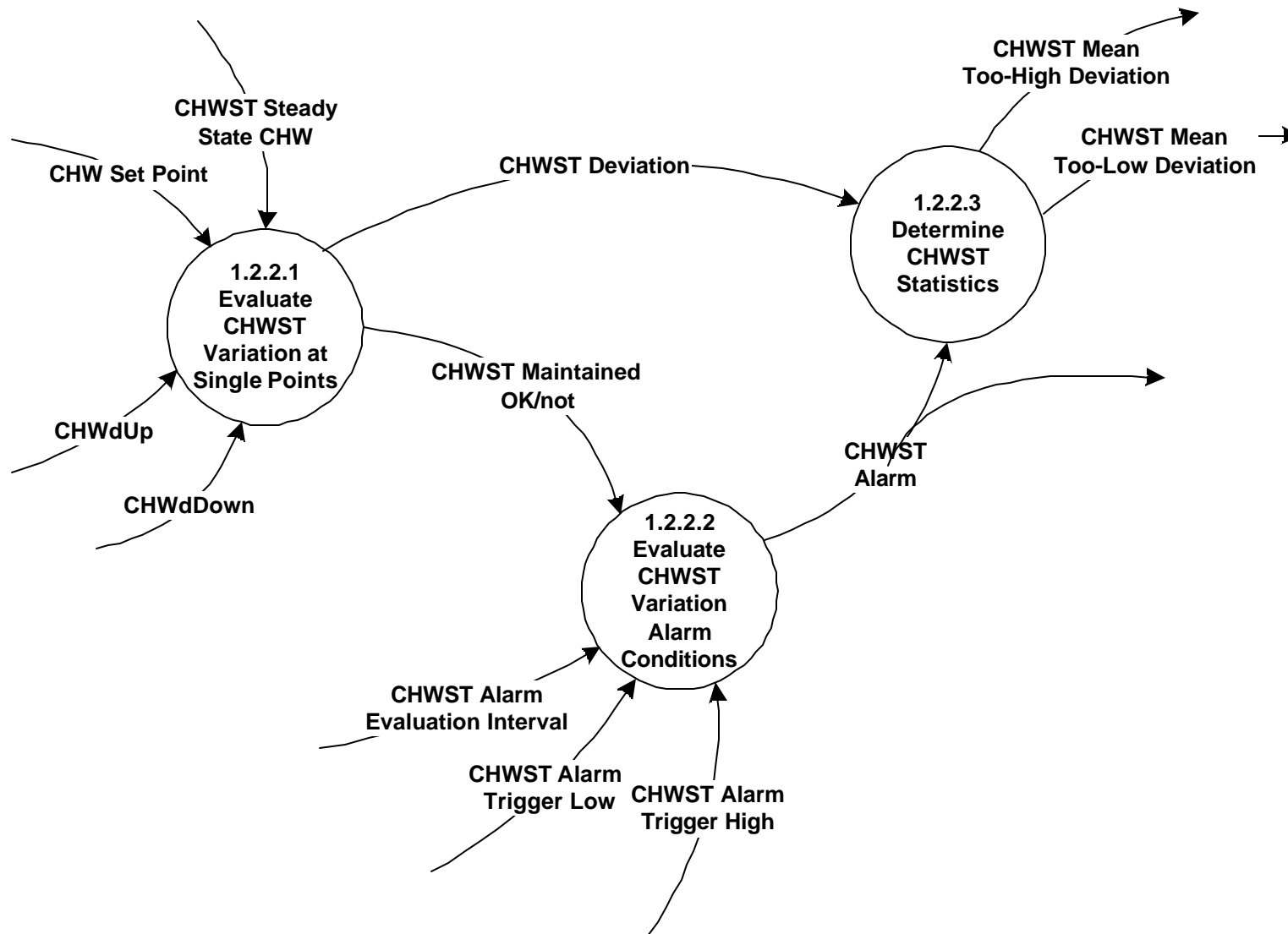

Automated Diagnostics	Version: 1.1
Software Requirements Specification	Date: 8/28/2003
Software Requirements Specification 1-1.DOC 8/29/2003	

## 1.2.2.1 Evaluate CHWST Variation at Single Points

Calculate the upper bound for acceptable Chilled Water Temperature using

$$\text{CHWST Upper Bound} = \text{CHW Setpoint} + (\text{CHWdUp})$$

Calculate the acceptable lower bound for the Chilled Water Temperature using

$$\text{CHWST Lower Bound} = \text{CHW Setpoint} - (\text{CHWdDown}).$$

Compare the Chilled Water Supply Temperature (CHWST) for steady state to the CHWST Upper Bound and CHWST Lower Bound.

If CHWST Steady State CHW > CHWST Upper Bound, then  
set CHWST Maintained OK/not = "Too high" for the current time.  
If CHWST Steady State CHW <= CHWST Upper Bound  
and CHWST Steady State CHW >= CHW Lower Bound, then  
set CHWST Maintained OK/not = "OK" for the current time.  
If CHWST Steady State CHW < CHWST Lower Bound, then  
set CHWST Maintained OK/not = "Too low" for the current time.

Calculate the CHW Temperature Deviation for a single point (current time)

$$\text{CHWST Deviation} = \text{CHWST Steady State CHW} - \text{CHW Setpoint}.$$

Ref file: 2.1CHW temperature control.doc

Automated Diagnostics	Version: 1.1
Software Requirements Specification	Date: 8/28/2003
Software Requirements Specification 1-1.DOC 8/29/2003	

## 1.2.2.2 Evaluate CHWST Variation Alarm Conditions

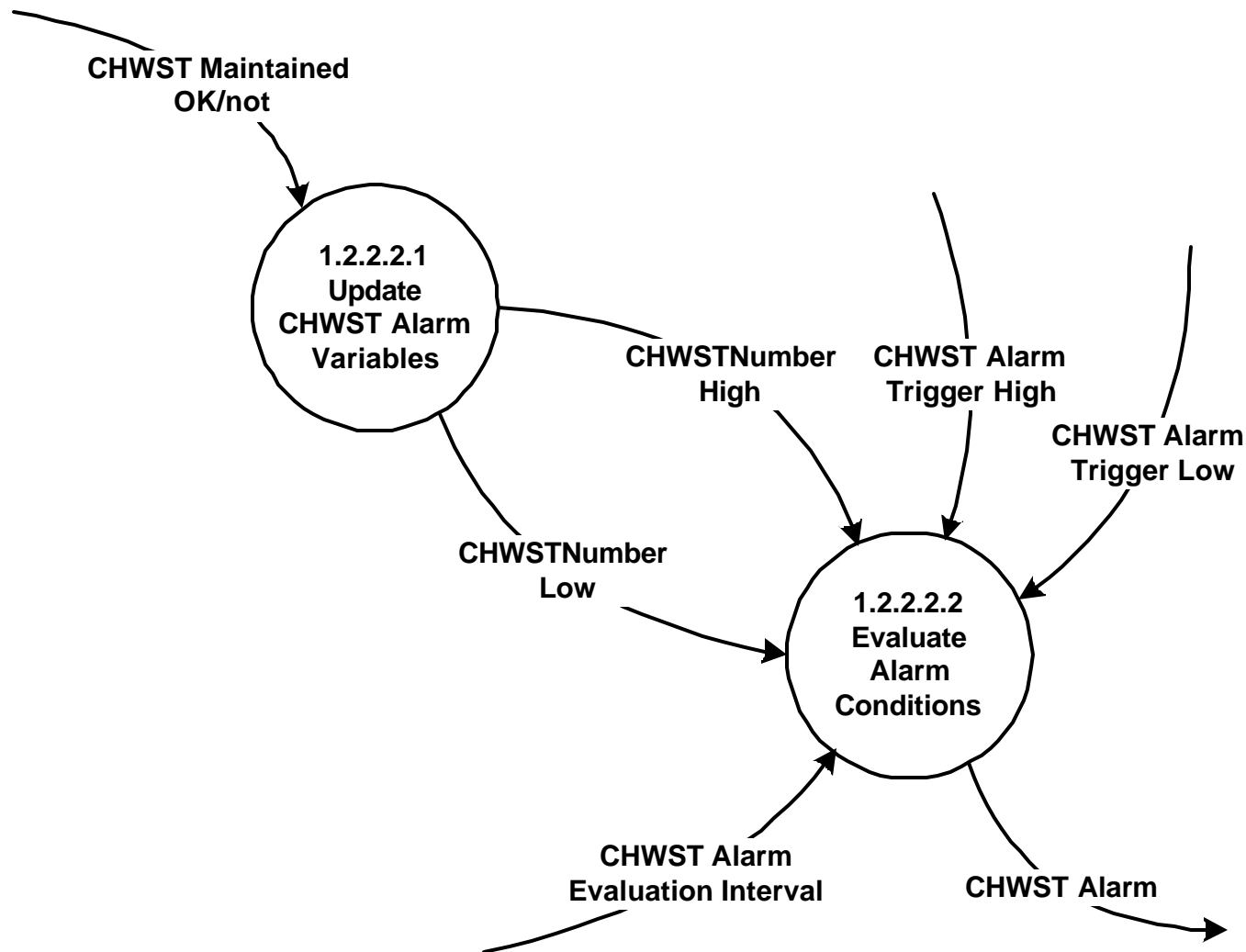



Automated Diagnostics	Version: 1.1
Software Requirements Specification	Date: 8/28/2003
Software Requirements Specification 1-1.DOC 8/29/2003	

## 1.2.2.2.1 Update CHWST Alarm Variables

Update the variable CHWST Maintained OK/not Array

Update all values in the array, adding the current value of CHWST Maintained OK/not to the array and by dropping the oldest value of CHWST Maintained OK/not from the array.

Update values for CHWSTNumber High and CHWSTNumber Low.

Set CHWSTNumber High = number of values "Too High" appearing in CHWST Maintained OK/not Array.

Set CHWSTNumber Low = number of values "Too Low" appearing in CHWST Maintained OK/not Array.

[Determine whether this evaluation should be done during initial start-up processing (this shouldn't really be part of the DFDs because it represents initialization and control),

If Total Number of Time Steps Processed < CHWST Alarm Evaluation Interval, then terminate processing of 2.8.2 (i.e., do not evaluate CHWST Variation Alarm Conditions).

Otherwise, continue with 2.8.2 processing.]

Ref file: 2.1CHW temperature control.doc

Automated Diagnostics	Version: 1.1
Software Requirements Specification	Date: 8/28/2003
Software Requirements Specification 1-1.DOC 8/29/2003	

## 1.2.2.2 Evaluate Alarm Conditions

Calculate values for CHWSTFraction High and CHWSTFraction Low.

$$\text{CHWSTFraction High} = \text{CHWSTNumber High} / (\text{CHWST Alarm Evaluation Interval})$$

$$\text{CHWSTFraction Low} = \text{CHWSTNumber Low} / (\text{CHWST Alarm Evaluation Interval})$$

Compare CHWSTFraction High with CHWST Alarm Trigger High.  
 Compare CHWSTFraction Low with CHWST Alarm Trigger Low.

If CHWSTFraction High  $\geq$  CHWST Alarm Trigger High, then  
 set CHWST Alarm = "Too High."

If CHWSTFraction High  $<$  CHWST Alarm Trigger High and CHWSTFraction Low  $<$  CHWST  
 Alarm Trigger Low, then  
 set CHWST Alarm = "OK".

If CHWSTFraction Low  $\geq$  CHWST Alarm Trigger Low, then  
 set CHWST Alarm = "Too Low."

Notes: Conclusions regarding a fault existing or not based on individual points are likely to be unreliable. Conclusions are likely to best be made by considering a high percentage of points over some period of time exceeding some minimum time, e.g., a day or a week (24 hours or 168 hours). Therefore, we base the assignment of CHWST Alarm on a minimum set of points rather than individual points.

Ref file: 2.1CHW temperature control.doc

Automated Diagnostics	Version: 1.1
Software Requirements Specification	Date: 8/28/2003
Software Requirements Specification 1-1.DOC 8/29/2003	

### 1.2.2.3 Determine CHWST Statistics\*

If CHWSTAlarm = Too High, then

Calculate mean CHWST for the times corresponding to the too-high points in the CHWST Maintained OK/not Array.

$$\text{CHWST Mean Too-High Deviation} = \frac{\text{Sum [CHWST Deviation(time index)]}}{(\text{CHWSTNumber High})},$$

where time index takes values between the current time and (CHWST Alarm Evaluation Interval - 1) time steps ago and the sum only includes values of CHWST Deviation for which CHWST Maintained OK/not = "Too High".

Set Mean Too Low CHWST Deviation = null.

If CHWSTAlarm = Too Low, then

Calculate mean CHWST for the times corresponding to the too-low points in the CHWST Maintained OK/not Array.

$$\text{CHWST Mean Too-Low Deviation} = \frac{\text{Sum [CHWST Deviation(time index)]}}{(\text{CHWSTNumber Low})},$$

where time index takes values between the current time and (CHWST Alarm Evaluation Interval - 1) time steps ago and the sum only includes values of CHWST Deviation for which CHWST Maintained OK/not = "Too Low".

Set Mean Too High CHWST Deviation = null.

Note: This process is proposed for Round 2. Also, additional or other statistics could be calculated in this process. These should also be proposed for Round 2.

Automated Diagnostics	Version: 1.1
Software Requirements Specification	Date: 8/28/2003
Software Requirements Specification 1-1.DOC 8/29/2003	

### 1.3 Diagnose Chiller Cycling

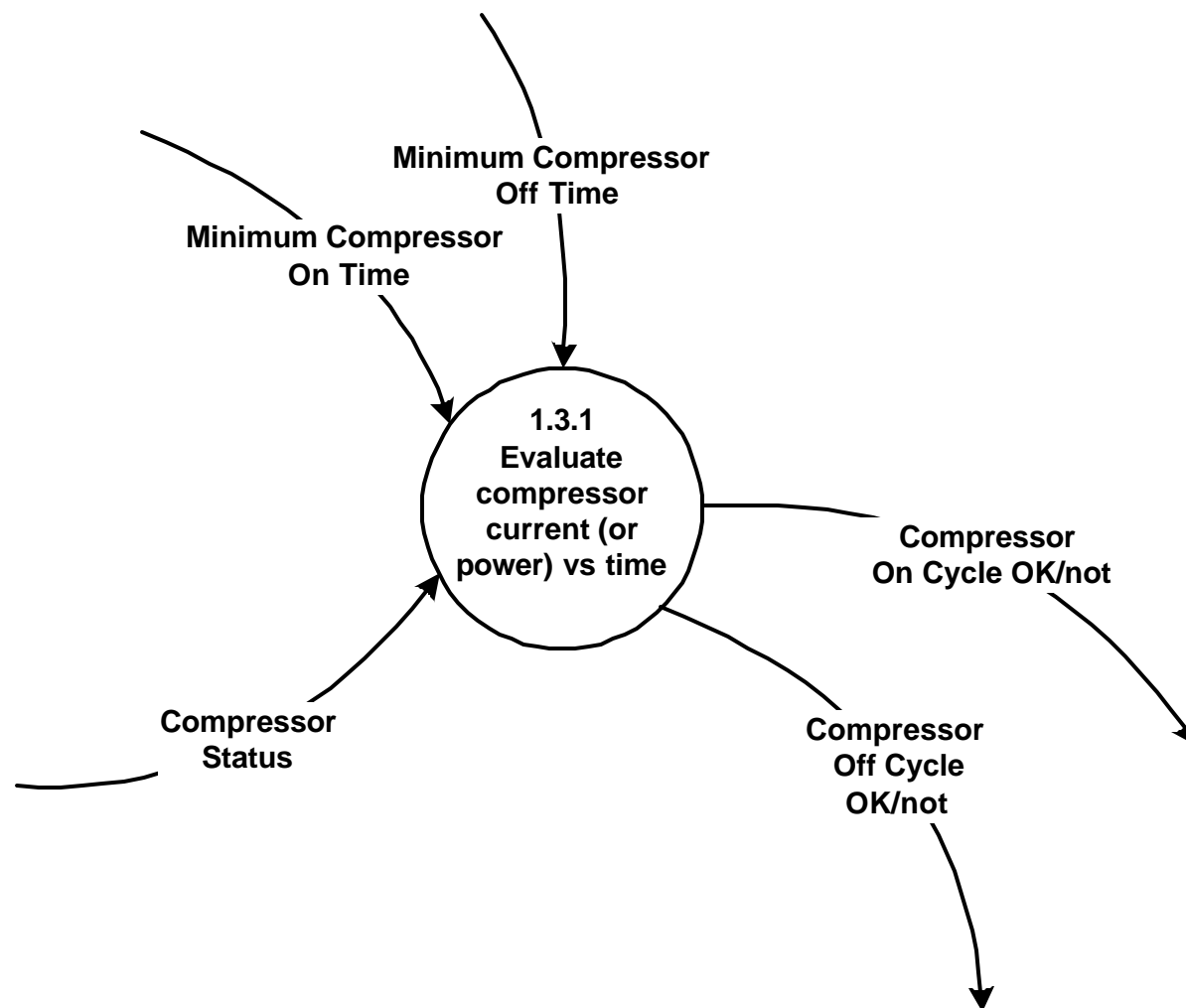

Automated Diagnostics	Version: 1.1
Software Requirements Specification	Date: 8/28/2003
Software Requirements Specification 1-1.DOC 8/29/2003	

### 1.3.1 Evaluate Compressor current (or power) vs time

If Compressor Status = "On" and Last Compressor Status = "On", then terminate this evaluation. Nothing new to check.

If Compressor Status = "On" and Last Compressor Status = "Off," then set Last Compressor Switch On Time = Current Time and check Last Compressor Off Interval.

Calculate the Last Compressor Off Interval using

$$\text{Last Compressor Off Interval} = \text{Last Compressor Switch On Time} - \text{Last Compressor Switch Off Time}$$

If Last Compressor Off Interval  $\geq$  Minimum Compressor Off Time, then set Compressor Off Cycle OK/not = "OK."

If Last Compressor Off Interval  $<$  Minimum Compressor Off Time, then set Compressor Off Cycle OK/not = "not OK." The compressor is not staying off long enough during cycling. Possible causes include an incorrectly specified minimum off time in the control algorithm or for compressors with minimum on/off times controlled by a relay a failed relay or one requiring adjustment.

If Compressor Status = "Off" and Last Compressor Status = "Off," then terminate this evaluation. Nothing new to check.

If Compressor Status = "Off" and Last Compressor Status = "On", then set Last Compressor Switch Off Time = Current Time and check Last Compressor On Interval.

Calculate the Last Compressor On Interval using

$$\text{Last Compressor On Interval} = \text{Last Compressor Switch Off Time} - \text{Last Compressor Switch On Time}$$

If Last Compressor On Interval  $\geq$  Minimum Compressor On Time, then Compressor On Cycle OK/not = "OK."

If Last Compressor On Interval  $<$  Minimum Compressor On Time, then Compressor On Cycle OK/not = "not OK." The compressor is not staying on long enough during cycling. Possible causes include an incorrectly specified minimum on time in the control algorithm or for compressors with minimum on/off times controlled by a relay a failed relay or one requiring adjustment.

Update Last Compressor Status : Set Last Compressor Status = Compressor Status\*

\*This over-writes previous compressor status with current status and should not be performed if previous status is required in subsequent processing.

Ref: 4.x chiller cycling.doc

Automated Diagnostics	Version: 1.1
Software Requirements Specification	Date: 8/28/2003
Software Requirements Specification 1-1.DOC 8/29/2003	

## 1.5.0 Diagnose Interlocks

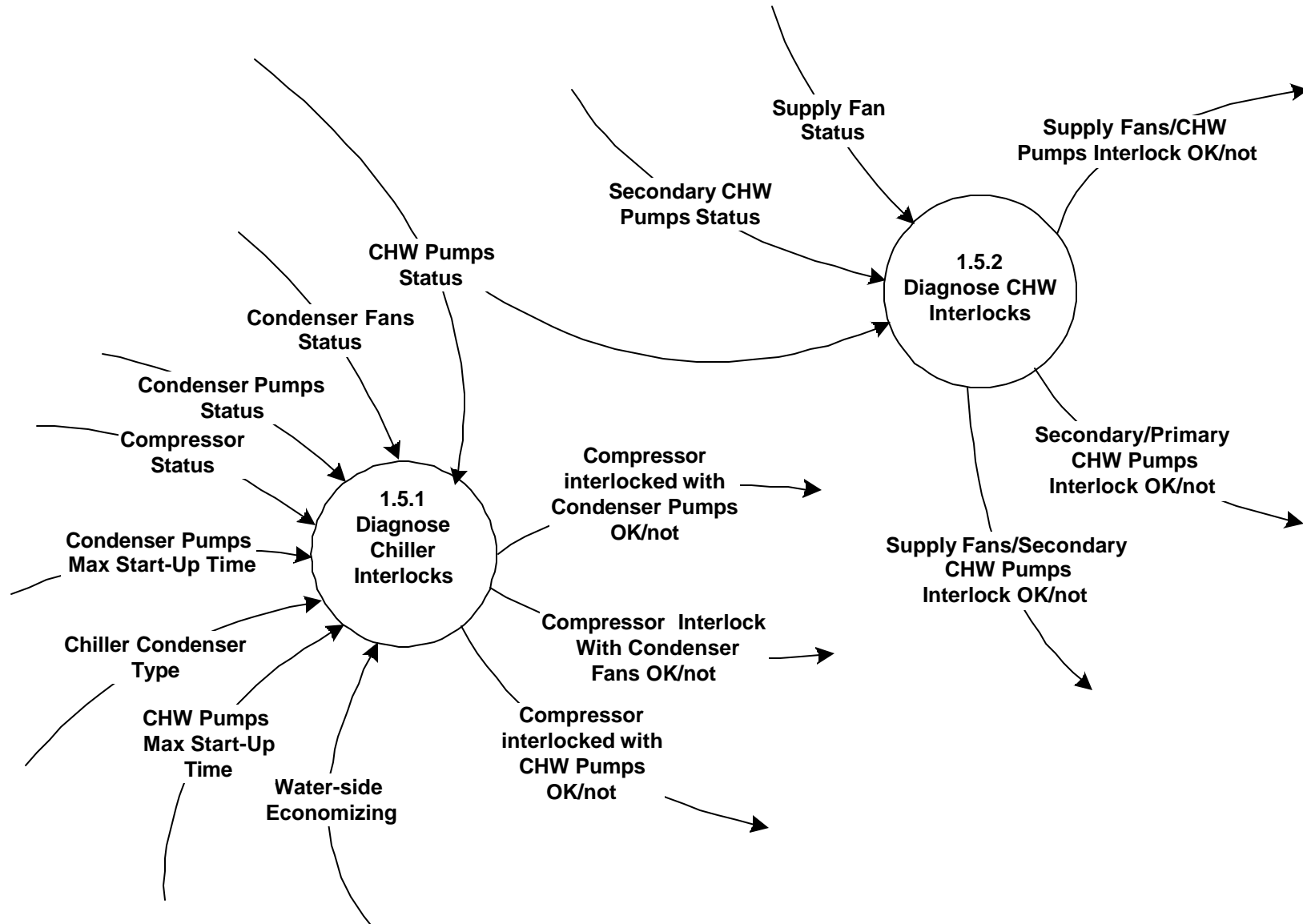

Automated Diagnostics	Version: 1.1
Software Requirements Specification	Date: 8/28/2003
Software Requirements Specification 1-1.DOC 8/29/2003	

### 1.5.1.1 Verify Proper Condenser Pumps/Compressor Interlock

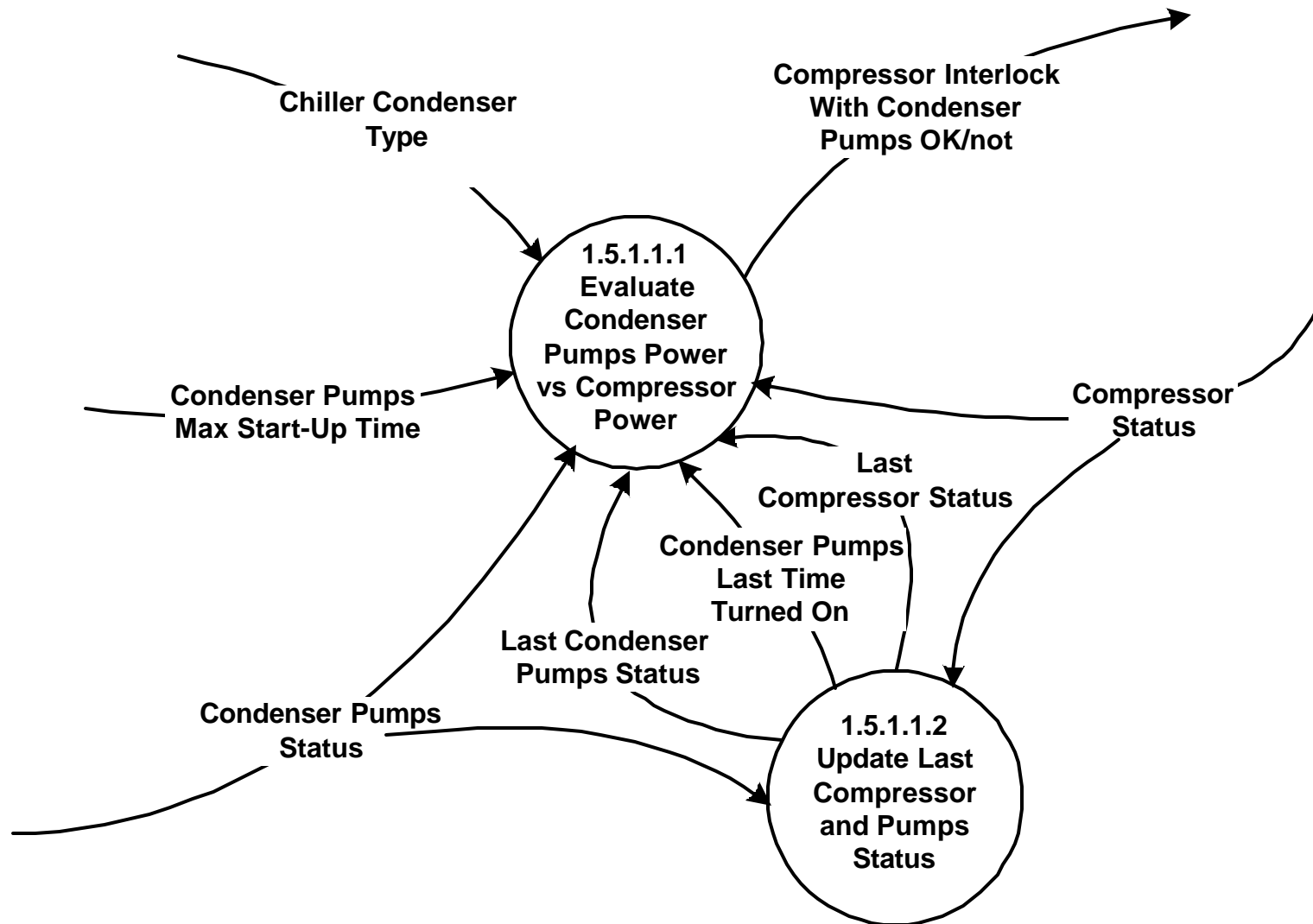

Automated Diagnostics	Version: 1.1
Software Requirements Specification	Date: 8/28/2003
Software Requirements Specification 1-1.DOC 8/29/2003	

### 1.5.1.1.1 Evaluate Condenser Pumps Power vs Compressor Power

If Chiller Condenser Type = Air-Cooled, then terminate this analysis.

If Chiller Condenser Type = Water-cooled, then

compare the compressor status and condenser-pumps status for the current time.

If the Compressor Status = "On" and the Condenser-Pumps Status = "On," then Compressor Interlock With Condenser Pumps OK/not = "OK"

If the Compressor Status = "Off" and the Condenser-Pumps Status = "Off," then Compressor Interlock With Condenser Pumps OK/not = "OK," unless

the Compressor Status = "Off" and Last Compressor Status = "Off," and current Condenser Pumps Status = "Off" and Last Condenser Pumps Status = "On", then the condenser pumps are cycling (turning on and off) unnecessarily and Compressor Interlock With Condenser Pumps OK/not = "Not OK. Repeated frequent cycling will shorten the life of the condenser pumps."

If the Compressor Status = "On" and the Condenser-Pumps Status = "Off," then Compressor Interlock With Condenser Pumps OK/not = "not OK." The chiller cannot reject heat and this could result in damage to the compressor.

If the Compressor Status = "Off" and the Condenser-Pumps Status = "On," then further evaluation is required

If Current Time - Condenser Pumps Last Time Turned On <= Condenser Pumps Max Start-Up Time, then Compressor Interlock With Condenser Pumps OK/not = "OK" (for now; actually this corresponds to no fault detected).

If Current Time - Condenser Pumps Last Time Turned On > CondenserPumps Max Start-Up Time, then Compressor Interlock With Condenser Pumps OK/not = "Not OK." The condenser pumps are turning on too much in advance of the chiller and wasting energy.



Automated Diagnostics	Version: 1.1
Software Requirements Specification	Date: 8/28/2003
Software Requirements Specification 1-1.DOC 8/29/2003	

### 1.5.1.1.2 Update Last Compressor and Pumps Status

If Condenser Pumps Status = "On" and Last Condenser Pumps Status = "Off", then  
set Condenser Pumps Last Time Turned On = Current Time.

Otherwise, do not change Condenser Pumps Last Time Turned On, i.e.,  
set Condenser Pumps Last Time Turned On = Condenser Pumps Last Time Turned On.

Then,

Set Last Compressor Status = Compressor Status.\*

Set Last Condenser-Pumps Status = Condenser-Pumps Status.\*

\*These actions over-write the previous statuses and should not be performed if the previous statuses are required in subsequent processing.

Automated Diagnostics	Version: 1.1
Software Requirements Specification	Date: 8/28/2003
Software Requirements Specification 1-1.DOC 8/29/2003	

## 1.5.1.2.1 Evaluate Condenser Fans Power vs Compressor Power

If Chiller Condenser Type = Water-Cooled, terminate this analysis.

If Chiller Condenser Type = Air-cooled, then

Compare the compressor status and condenser-fan status for the current time.

If the Compressor Status = "On" and the Condenser-Fans Status = "On," then Compressor Interlock With Condenser Fans OK/not = "OK"

If the Compressor Status = "Off" and the Condenser-Fans Status = "Off," then Compressor Interlock With Condenser Fans OK/not = "OK."

If the Compressor Status = "On" and the Condenser-Fans Status = "Off," then Compressor Interlock With Condenser Fans OK/not = "Not OK." The chiller cannot reject heat and this could result in damage to the compressor.

If the Compressor Status = "Off" and the Condenser-Fans Status = "On," then Compressor Interlock With Condenser Fans OK/not = "Not OK." The fans are running unnecessarily and wasting energy.

Automated Diagnostics	Version: 1.1
Software Requirements Specification	Date: 8/28/2003
Software Requirements Specification 1-1.DOC 8/29/2003	

### 1.5.1.3 Verify Proper CHW Pumps/ Compressor Interlock

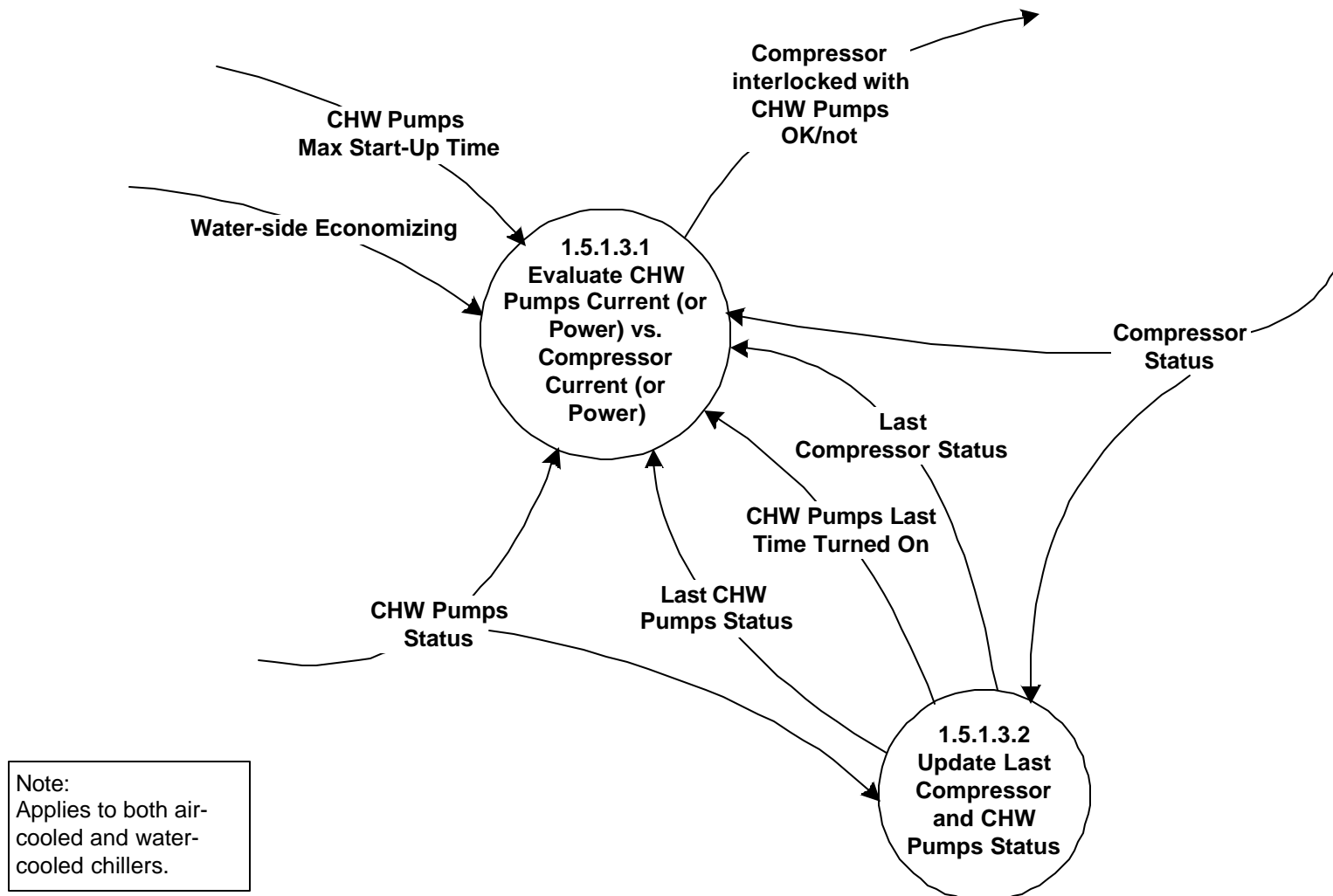

Automated Diagnostics	Version: 1.1
Software Requirements Specification	Date: 8/28/2003
Software Requirements Specification 1-1.DOC 8/29/2003	

### 1.5.1.3.1 Evaluate Chilled Water Pumps Power vs. Compressor Power

Compare the chiller status and chilled water pumps status for the current time.

If the Compressor Status = "On" and the CHW Pumps Status = "On," then Compressor Interlock With CHW Pumps OK/not = "OK"

If the Compressor Status = "Off" and the CHW Pumps Status = "Off," then Compressor Interlock With CHW Pumps OK/not = "OK," unless

the Compressor Status = "Off" and Last Compressor Status = "Off," and current CHW Pumps Status = "Off" and Last CHW Pumps Status = "On", then the condenser pumps are cycling (turning on and off) unnecessarily and Compressor Interlock With CHW Pumps OK/not = "Not OK." Repeated frequent cycling will shorten the life of the CHW Pumps.

If the Compressor Status = "On" and the CHW-Pumps Status = "Off," then Compressor Interlock With CHW Pumps OK/not = "not OK." The chiller is operating without a load. Energy is being wasted and damage to the chiller may result.

If the Compressor Status = "Off" and the CHW-Pumps Status = "On," then further evaluation is required.

If Water-Side Economizing = "Yes", then Compressor Interlock With Condenser Pumps OK/not = "OK" (as far as we can tell).

If Water-Side Economizing = "No", and

If Current Time - CHW Pumps Last Time Turned On  $\leq$  CHW Pumps Max Start-Up Time, then Compressor Interlock With CHW Pumps OK/not = "OK" (for now; actually this corresponds to no fault detected).

If Current Time - CHW Pumps Last Time Turned On  $>$  CHW Pumps Max Start-Up Time, then Compressor Interlock With CHW Pumps OK/not = "Not OK." The CHW pumps are turning on too much in advance of the chiller and wasting energy.

Note: Applies to both water-cooled and air-cooled chillers.

Ref. File: 5.3.2 CHW Pumps interlock.doc

Automated Diagnostics	Version: 1.1
Software Requirements Specification	Date: 8/28/2003
Software Requirements Specification 1-1.DOC 8/29/2003	

### 1.5.1.3.2 Update Last Compressor and CHW Pumps Status

If CHW Pumps Status = "On" and Last CHW Pumps Status = "Off", then  
set CHW Pumps Last Time Turned On = Current Time.

Otherwise, do not change CHW Pumps Last Time Turned On, i.e.,  
set CHW Pumps Last Time Turned On = CHW Pumps Last Time Turned On.

Then,

set Last Compressor Status = Compressor Status.\*

and

set Last CHW Pumps Status = CHW Pumps Status.

\*This overwrites the previous status and should not be performed if subsequent processing requires the previous status.

Automated Diagnostics	Version: 1.1
Software Requirements Specification	Date: 8/28/2003
Software Requirements Specification 1-1.DOC 8/29/2003	

## 1.5.2 Diagnose CHW Interlocks

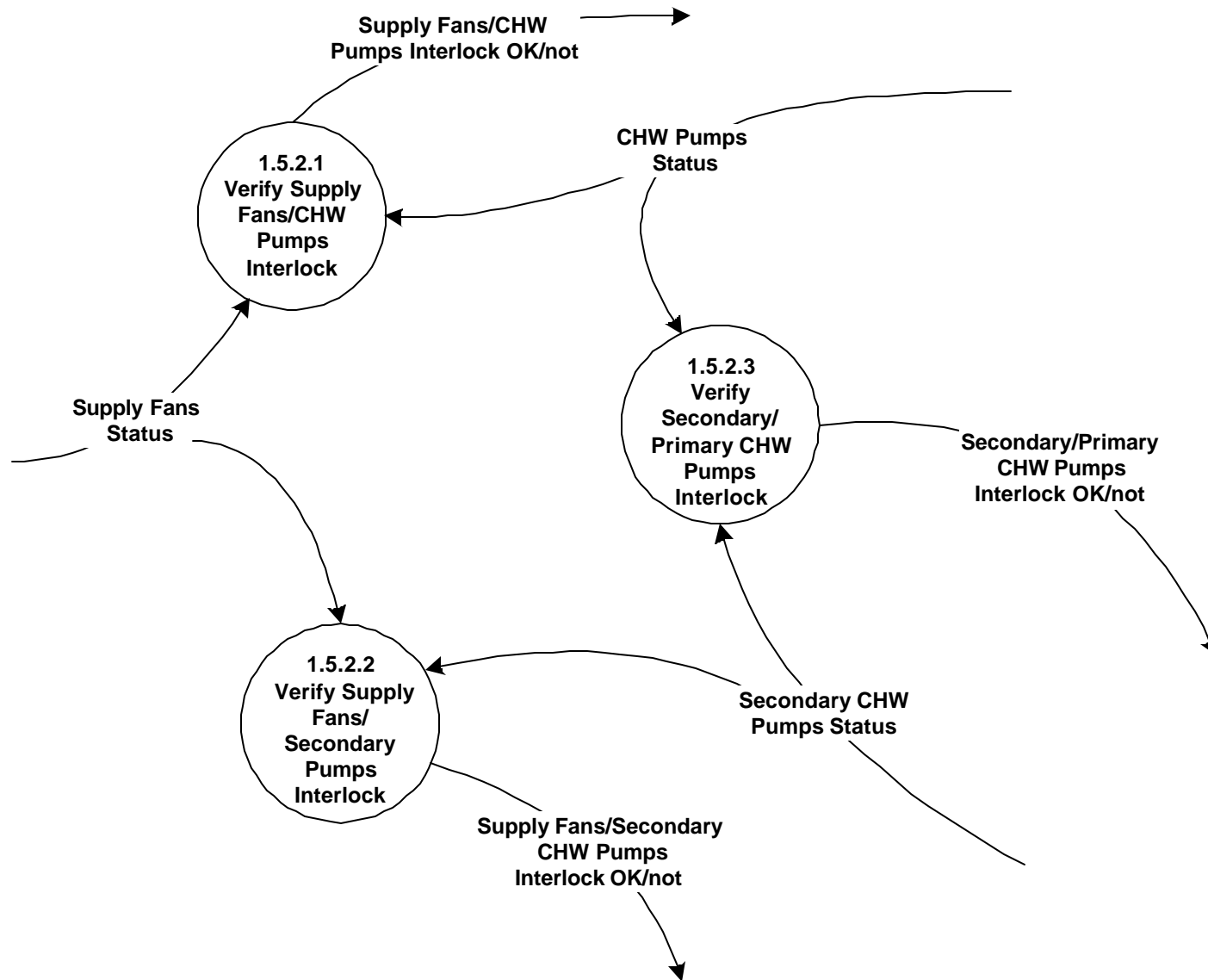

Automated Diagnostics	Version: 1.1
Software Requirements Specification	Date: 8/28/2003
Software Requirements Specification 1-1.DOC 8/29/2003	

## 1.5.2.1 Verify Supply Fans/CHW Pumps Interlock

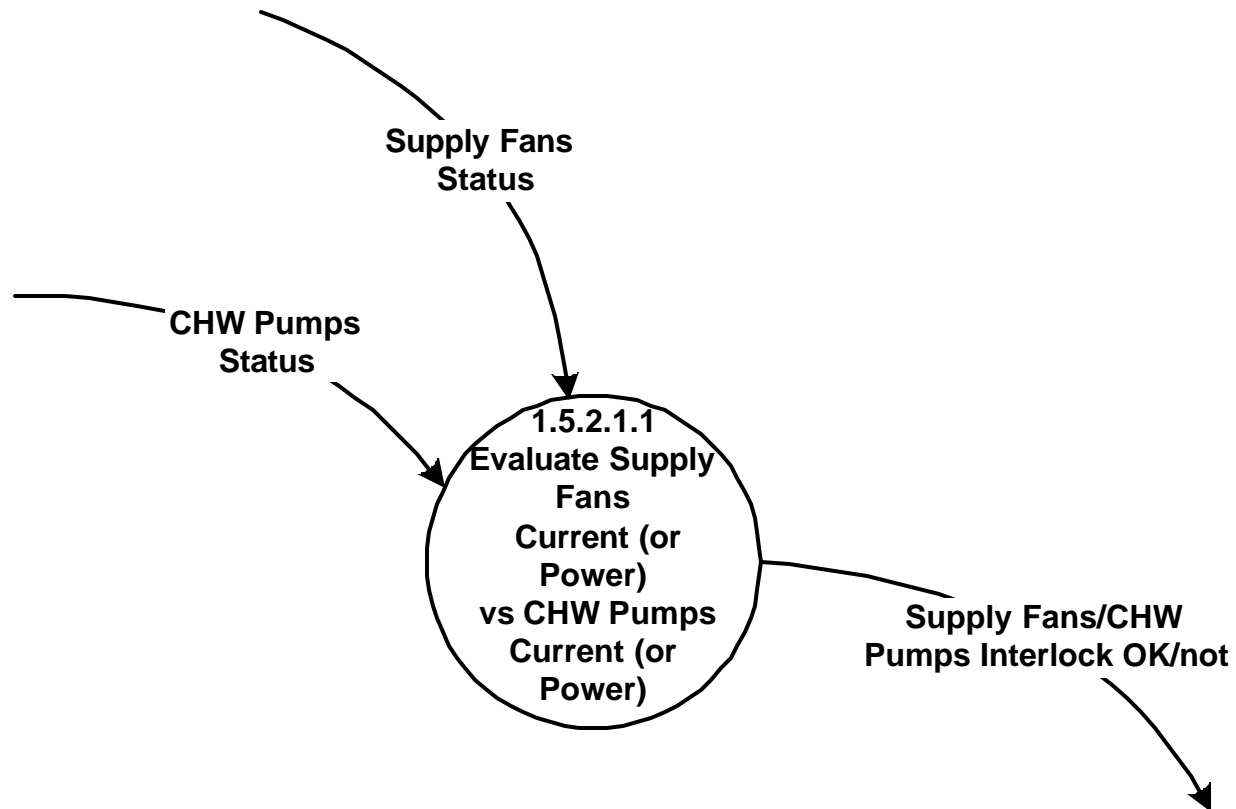

Automated Diagnostics	Version: 1.1
Software Requirements Specification	Date: 8/28/2003
Software Requirements Specification 1-1.DOC 8/29/2003	

### 1.5.2.1.1 Evaluate Supply Fans Current (or Power) vs Primary CHW Pumps Current (or Power)

For each set of primary CHW Pumps, Compare the CHW Pumps Collective Status and Supply Fan Status for the supply fans for each air handler served by this set of specific CHW Pumps.

If the CHW Pumps Collective Status = "On" and the Supply Fan Status = "On" for at least one of the air handlers served by this CHW Pumps, then set the Supply Fans/CHW Pumps Interlock OK/not for this set of CHW Pumps = "OK."

If the CHW Pumps Collective Status = "Off" and the Supply Fan Status = "Off" for all of the air handlers served by this set of CHW Pumps, then set the Supply Fans/CHW Pumps Interlock OK/not for this CHW Pumps="OK."

If the CHW Pumps Collective Status = "Off" and the Supply Fan Status = "On" for at least one of the air handlers served by this set of CHW Pumps, then set the Supply Fans/CHW Pumps Interlock OK/not for this set of CHW Pumps = "Possible problem with supply fan control--check to see if loads in the spaces served are being met for supply fans with Supply Fans Status = "On" that are part of air handlers served by these CHW Pumps. Occupant complaints about temperature or stuffiness may be in indicator of the load not being met.

If the CHW Pumps Collective Status = "On" and the Supply Fan Status = "Off" for all of the air handlers served by this set of CHW Pumps, then set the Supply Fans/CHW Pumps Interlock OK/not for this CHW Pumps = "Not OK." These CHW Pumps is operating unnecessarily and is wasting energy. The CHW Pumps should not operate unless at least one of the supply fans in an air handler served by these CHW Pumps is on.

Notes: This diagnostic can be applied to current (or power) measured for each supply fan individually or to the collective current for all supply fans served by a CHW pump together.

Equipment status is determined in Process 7.0.

Ref. File: 5.8 supply fan-CHW pump interlock.doc



Automated Diagnostics	Version: 1.1
Software Requirements Specification	Date: 8/28/2003
Software Requirements Specification 1-1.DOC 8/29/2003	

## 1.5.2.2 Verify Supply Fans/ Secondary Pumps Interlock

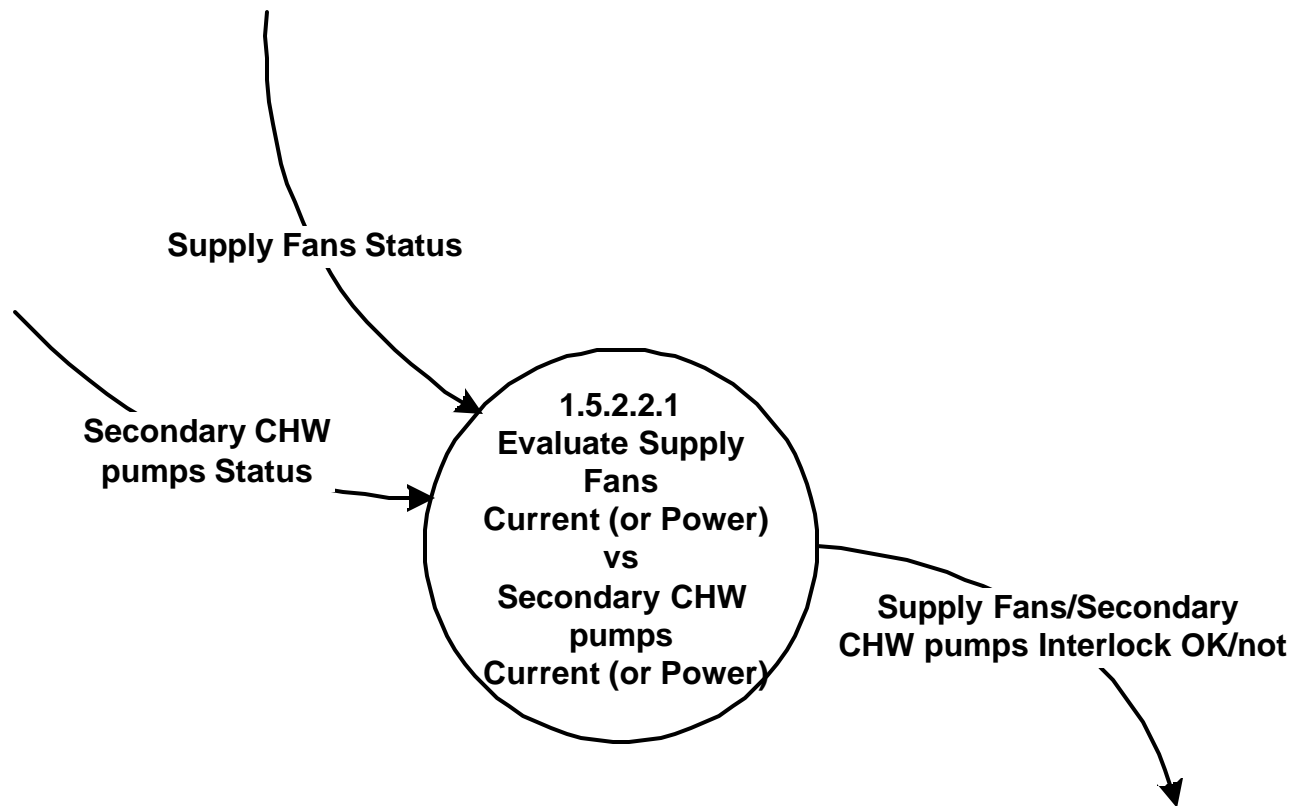

Automated Diagnostics	Version: 1.1
Software Requirements Specification	Date: 8/28/2003
Software Requirements Specification 1-1.DOC 8/29/2003	

### 1.5.2.2.1 Evaluate Supply Fans Current (or Power) vs Secondary CHW pumps Current (or Power)

For chilled-water distribution systems with secondary CHW pumps.

For each secondary set of CHW pumps,  
compare the Secondary CHW pumps Collective Status and Supply Fans Status for the supply fans for each air handler served by this specific secondary CHW pump.

If the Secondary CHW pumps Collective Status = "On" and the Supply Fans Status = "On" for at least one of the air handlers served by this set of secondary CHW pumps, then set the Supply Fans/Secondary CHW Pumps Interlock OK/not for this set of secondary CHW pumps = "OK."

If the Secondary CHW pumps Collective Status = "Off" and the Supply Fans Status = "Off" for all of the air handlers served by this set of secondary CHW pumps, then set the Supply Fans/Secondary CHW Pumps Interlock OK/not for this set of secondary CHW pumps = "OK."

If the Secondary CHW pumps Collective Status = "Off" and the Supply Fans Status = "On" for at least one of the air handlers served by this set of Secondary CHW pumps, then set the Supply Fans/Secondary CHW Pumps Interlock OK/not for this set of secondary CHW pumps = "Possible problem with supply fan control--check to see if loads in the spaces served are being met" for supply fans with Supply Fans Status = "On" that are part of air handlers served by this set of secondary CHW Pumps.

If the Secondary CHW pumps Collective Status = "On" and the Supply Fans Status = "Off" for all of the air handlers served by this set of Secondary CHW pumps, then set the Supply Fans/Secondary CHW Pumps interlock OK/not for this set of secondary CHW pump = "Not OK." This set of secondary CHW pumps is operating unnecessarily and is wasting energy. The set of secondary CHW pumps should not operate unless at least one of the supply fans in an air handler served by this set of secondary CHW pumps is on.

Notes: This diagnostic can be applied to current (or power) measured for each supply fan individually or to the collective current for all supply fans served by a set of secondary CHW pump together.

Equipment status is determined in Process 7.0.

Ref. File: 5.10 supply fan-2ndary CHW pump interlock.doc

Automated Diagnostics	Version: 1.1
Software Requirements Specification	Date: 8/28/2003
Software Requirements Specification 1-1.DOC 8/29/2003	

### 1.5.2.3 Verify Secondary/Primary CHW Pumps Interlock

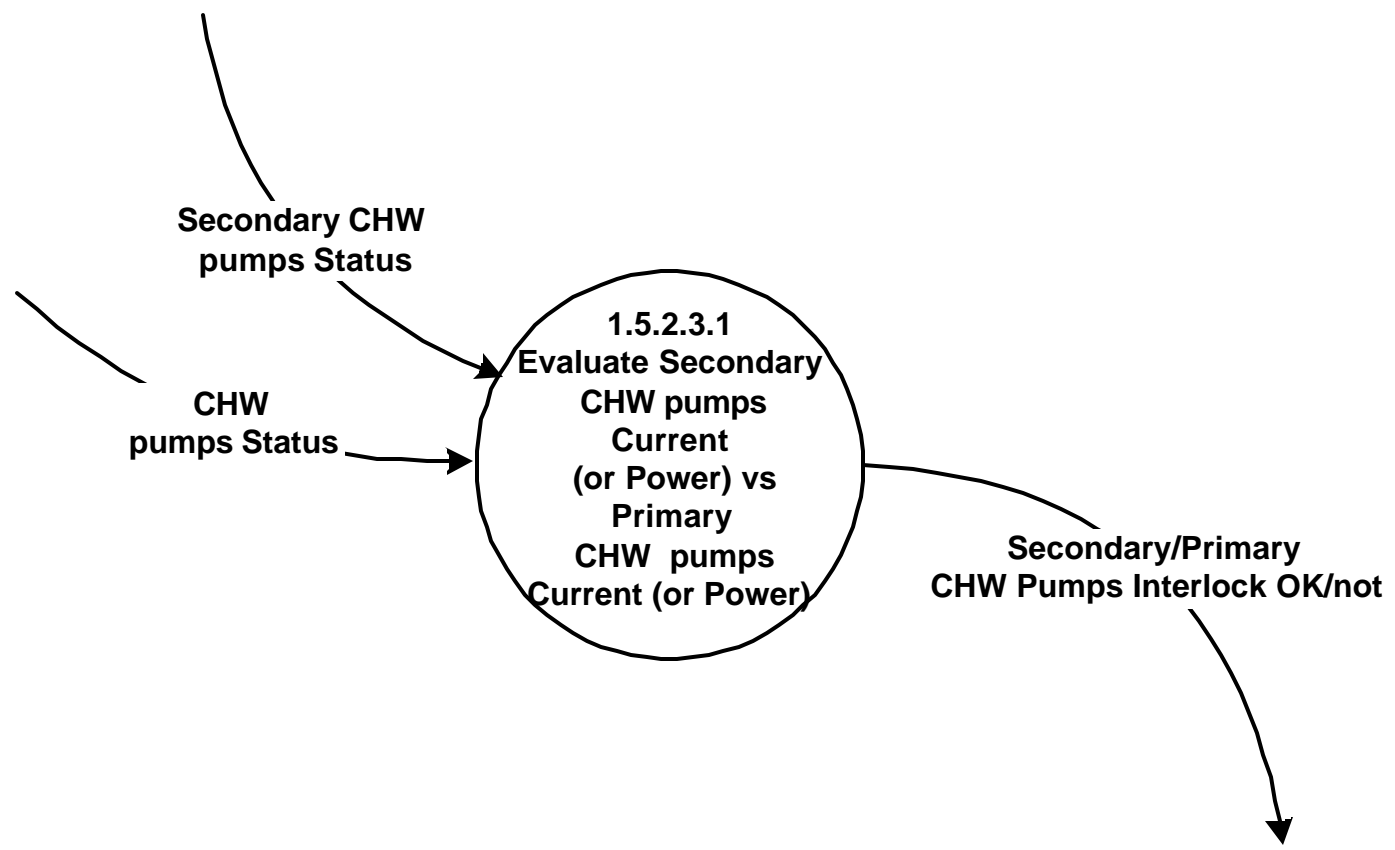

Automated Diagnostics	Version: 1.1
Software Requirements Specification	Date: 8/28/2003
Software Requirements Specification 1-1.DOC 8/29/2003	

### **1.5.2.3.1 Evaluate Secondary CHW pumps Current (or Power) vs Primary CHW Pumps Current (or Power)**

For each set of primary CHW pumps,

For each set of secondary CHW pumps served by the selected set of primary CHW Pumps,

Compare the primary CHW Pumps Collective Status and Secondary CHW pumps Collective Status for each set of secondary CHW pump served by this specific set of primary CHW Pumps.

If the primary CHW pumps Collective Status = "On" and the Secondary CHW pump Status = "On" for at least one of the secondary CHW pumps served by this set of primary CHW pumps, then set Secondary/Primary CHW Pumps Interlock OK/not for this set of primary CHW pump = "OK."

If the primary CHW pumps Collective Status = "Off" and the Secondary CHW pump Status = "Off" for all of the secondary CHW pumps served by this set of primary CHW pumps, then set Secondary/Primary CHW Pumps Interlock OK/not for this set of primary CHW pumps = "OK."

If the primary CHW pumps Collective Status = "Off" and the Secondary CHW pump Status = "On" for at least one of the secondary CHW pumps served by this set of primary CHW pumps, then set Secondary/Primary CHW Pumps Interlock OK/not for this set of primary CHW pumps = "Not OK." The secondary CHW pumps that are one are wasting energy. Secondary CHW pumps should only operate when the set of primary CHW pumps is operating.

If the primary CHW Pumps Collective Status = "On" and the Secondary CHW pump Status = "Off" for all of the secondary CHW pumps served by this set of primary CHW pumps, then set Secondary/Primary CHW Pumps Interlock OK/not for this set of primary CHW pumps = "Not OK." This set of primary CHW pumps is operating unnecessarily and is wasting energy. The set of primary CHW pump should not operate unless at least one of the secondary CHW pumps served by this set of primary CHW pumps is on.

Notes: This diagnostic can be applied to current (or power) measured for each secondary CHW pump individually or to the collective current for all secondary CHW pumps served by a CHW pump together.

Equipment status is determined in Process 7.0.

Ref. File: 5.9 secondary CHWP interlock.doc

Automated Diagnostics	Version: 1.1
Software Requirements Specification	Date: 8/28/2003
Software Requirements Specification 1-1.DOC 8/29/2003	

## 1.6.0 Diagnose Chiller Performance

**Placeholder only** for Round 2.

Chiller Performance is a candidate for development of diagnostics for Round 2.

Enforma help suggests 4 plots that may be useful for Chiller Performance Diagnostics:

- ✓ Compressor Power vs. Ambient Temperature
- ✓ Compressor Power vs. Condenser Inlet Temperature (cooling tower outlet temperature)
- ✓ Compressor Power vs. Chiller Delta T
- ✓ Compressor Power vs. Chiller Inlet Temperature

Automated Diagnostics	Version: 1.1
Software Requirements Specification	Date: 8/28/2003
Software Requirements Specification 1-1.DOC 8/29/2003	

## 2.0 Diagnose Cooling Tower

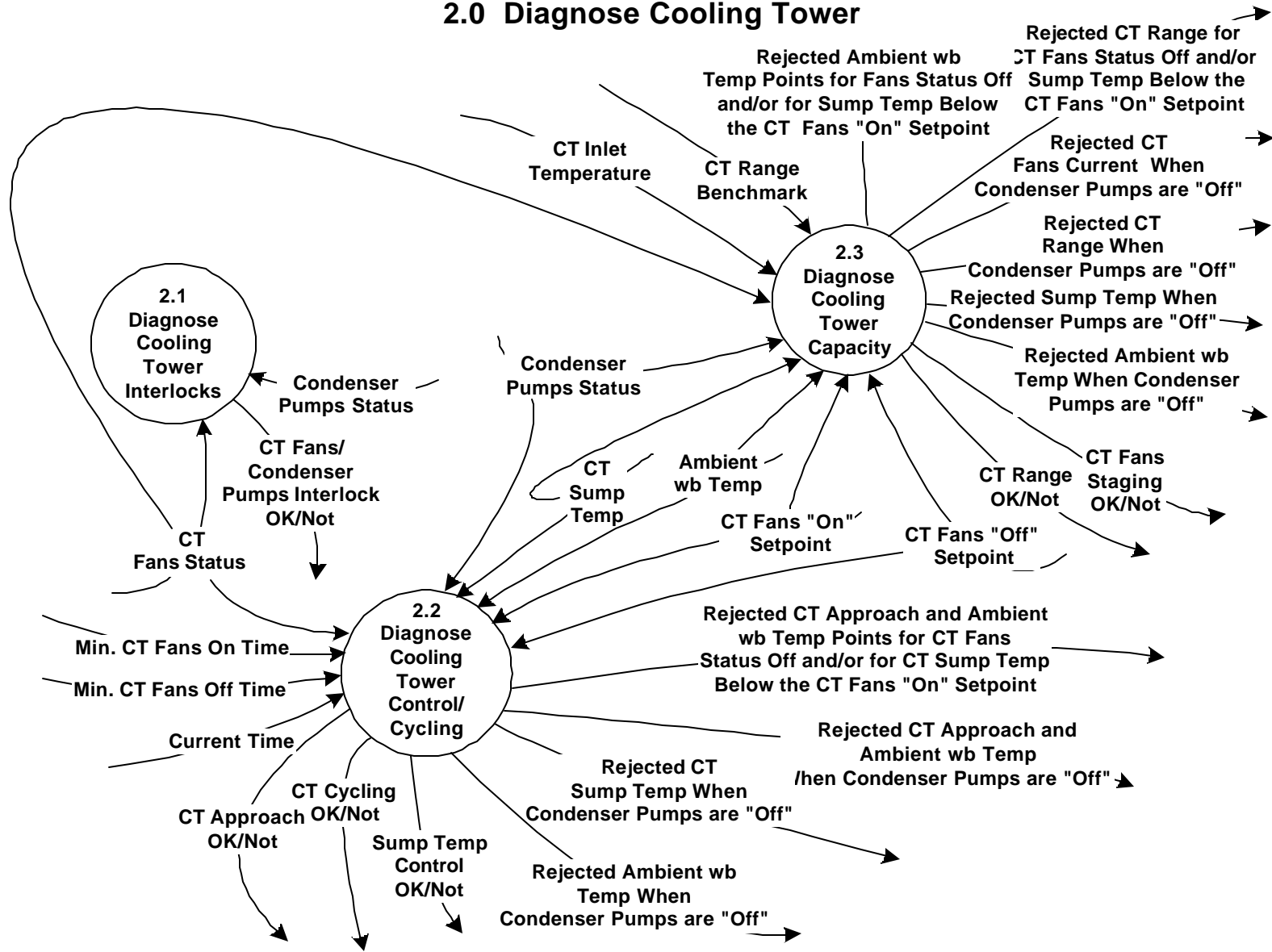

Automated Diagnostics	Version: 1.1
Software Requirements Specification	Date: 8/28/2003
Software Requirements Specification 1-1.DOC 8/29/2003	

## 2.1 Diagnose Cooling Tower Interlocks

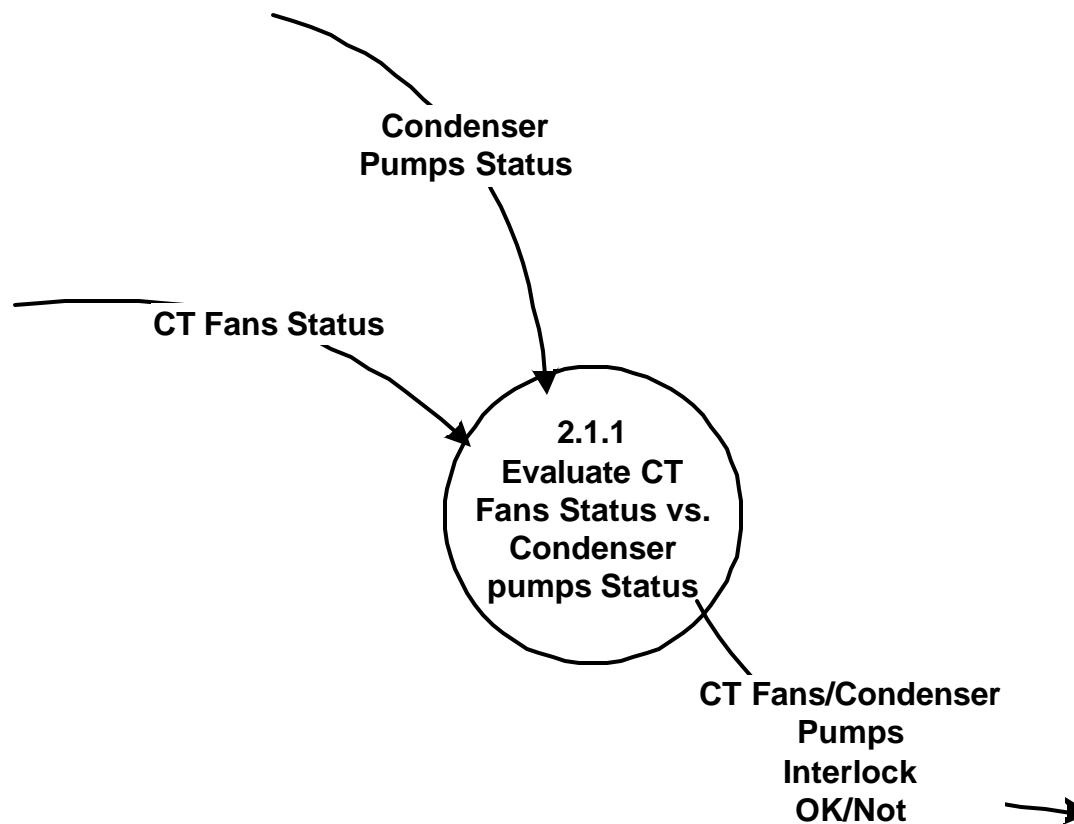

Automated Diagnostics	Version: 1.1
Software Requirements Specification	Date: 8/28/2003
Software Requirements Specification 1-1.DOC 8/29/2003	

## 2.1.1 Evaluate CT Fans Status vs. Condenser Pumps Status

Compare the CT Fans Status and Condenser Pumps Status for the current time.

If the CT Fans Status = "On" and the Condenser Pumps Status = "On," then CT Fans/Condenser Pumps Interlock OK/Not = "OK"

If the CT Fans Status = "Off" and the Condenser Pumps Status = "Off," then CT Fans/Condenser Pumps Interlock OK/Not = "OK."

If the CT Fans Status = "On" and the Condenser Pumps Status = "Off," then CT Fans/Condenser Pumps Interlock OK/Not = "Not OK." The CT Fans must be off when the condenser pumps are off, otherwise energy is being wasted.

If the CT Fans Status = "Off" and the Condenser Pumps Status = "On," then CT Fans/Condenser Pumps Interlock OK/Not = "OK." The cooling tower Fans may be off when the condenser pumps are running, but this should not always be the case.

Note: This process uses as inputs the CT Fans Status and the Condenser Pumps Status that are determined in Process 7.0.

Values of CT Fans/Condenser Pumps Interlock OK/Not = "OK" should be interpreted more precisely as "no problem has been detected with this interlock." It is possible that no problem is detected under current conditions, yet an interlock problem exists. This is particularly true when CT Fans Status = "Off" and Condenser Pumps Status = "On," which while OK under some conditions is not always OK. Additional diagnostics would be useful here.

Ref. File: 1.22 Evaluate Plot of CT Fan vs. CCP



Automated Diagnostics	Version: 1.1
Software Requirements Specification	Date: 8/28/2003
Software Requirements Specification 1-1.DOC 8/29/2003	

## 2.2 Diagnose Cooling Tower Temperature Control/Cycling

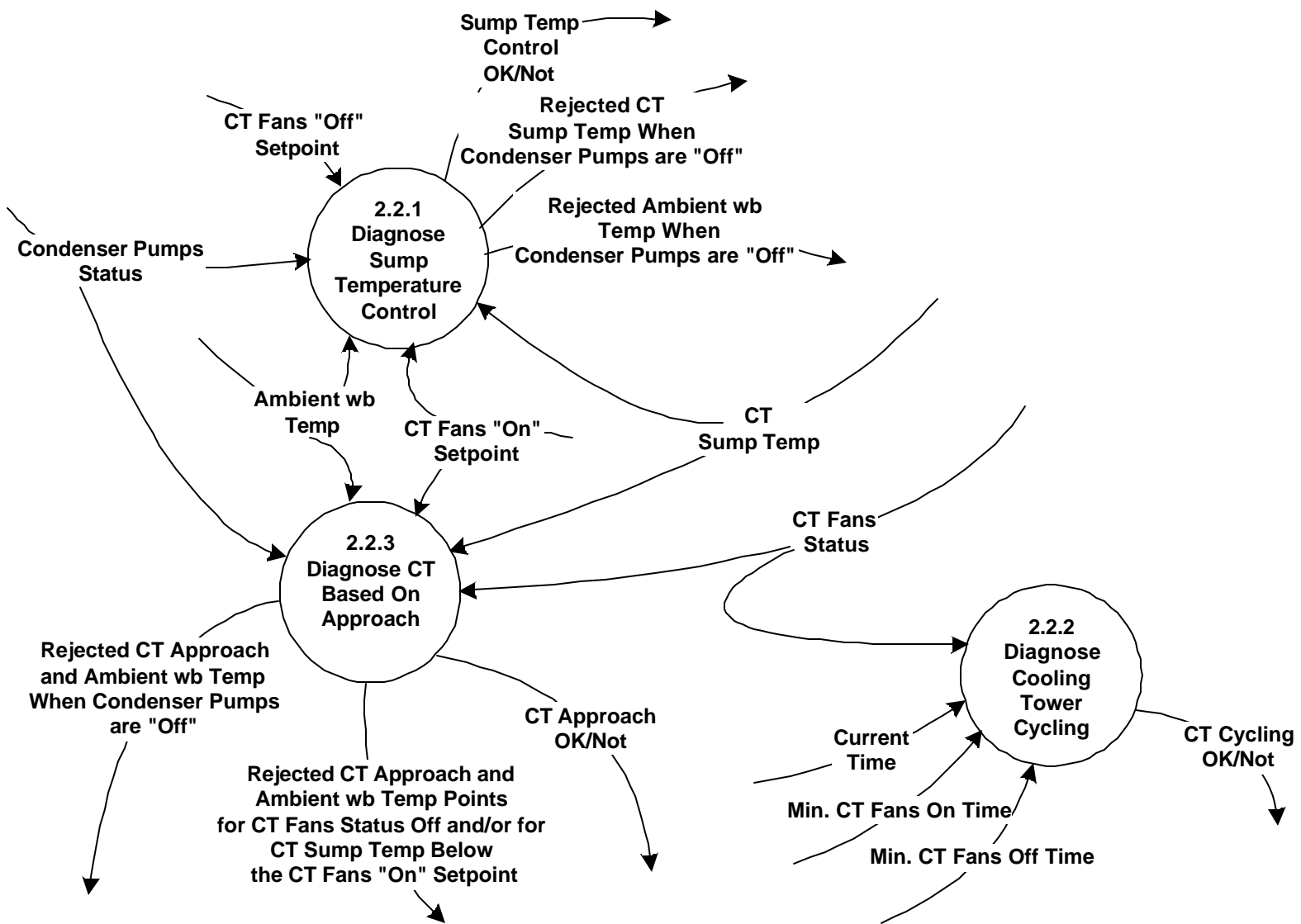

Automated Diagnostics	Version: 1.1
Software Requirements Specification	Date: 8/28/2003
Software Requirements Specification 1-1.DOC 8/29/2003	

## 2.2.1 Diagnose Sump Temperature Control

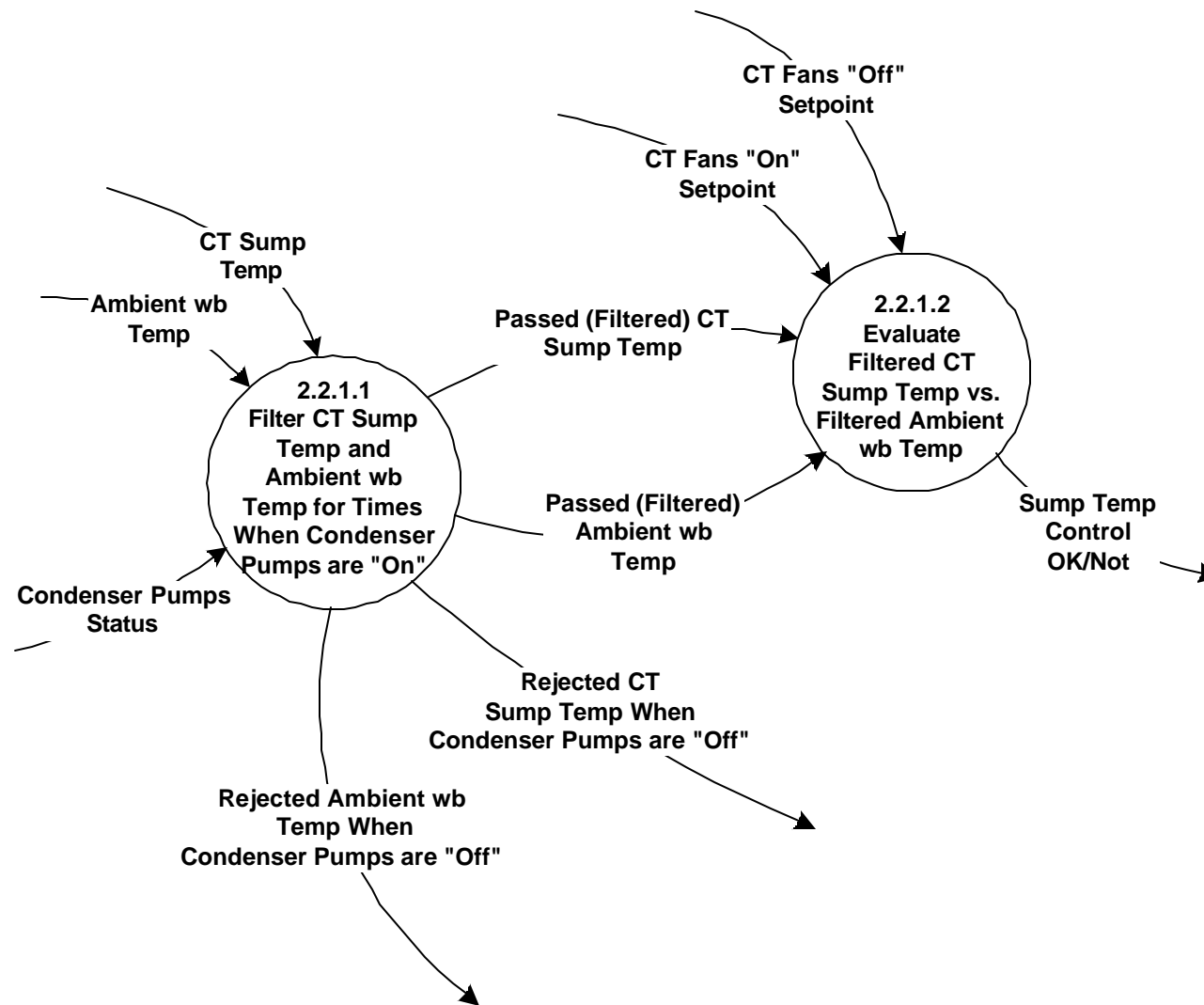

Automated Diagnostics	Version: 1.1
Software Requirements Specification	Date: 8/28/2003
Software Requirements Specification 1-1.DOC 8/29/2003	

### **2.2.1.1 Filter CT Sump Temp and Ambient wb Temp for Times When Condenser Pumps are On**

For each triplet of (Condenser Pumps Status, CT Sump Temperature, and Ambient wb Temperature)  
reject (i.e., filter out) those triplets for which Condenser Pumps Status = off.  
pass those triplets for which Condenser Pumps status = on.

Automated Diagnostics	Version: 1.1
Software Requirements Specification	Date: 8/28/2003
Software Requirements Specification 1-1.DOC 8/29/2003	

## 2.2.1.2 Evaluate Filtered CT Sump Temp vs. Filtered Ambient wb Temp

Determine if CT fans are on when Sump Temp is above its on setpoint

If Sump Temperature > CT Fans On Setpoint and CT Fans Status = "On,"  
then set Sump Temp Control OK/Not= "OK"

If Sump Temperature > CT Fans On Setpoint and CT Fans Status = "Off,"  
then set Sump Temp Control OK/Not= "Not OK. The CT fans are off but should be on."

Possible causes include:

- control problem
- sump temperature sensor problem
- electrical problem (motor failure)
- other problems with the fan motor

Determine if CT fans are off when sump Temp is below the off setpoint

If Sump Temperature <= CT Fans Off Setpoint and CT Fans Status = "On,"  
then set Sump Temp Control OK/Not= "Not OK. The CT fans are on but should be off."

Possible causes include:

- control problem
- actuator or relay problem

If Sump Temperature <= CT Fans Off Setpoint and CT Fans Status = "Off,"  
then set Sump Temp Control OK/Not= "OK."

Ref. File: 2.1.1 Sump Temperature Control Diagnostics

Automated Diagnostics	Version: 1.1
Software Requirements Specification	Date: 8/28/2003
Software Requirements Specification 1-1.DOC 8/29/2003	

## 2.2.2 Diagnose Cooling Tower Cycling

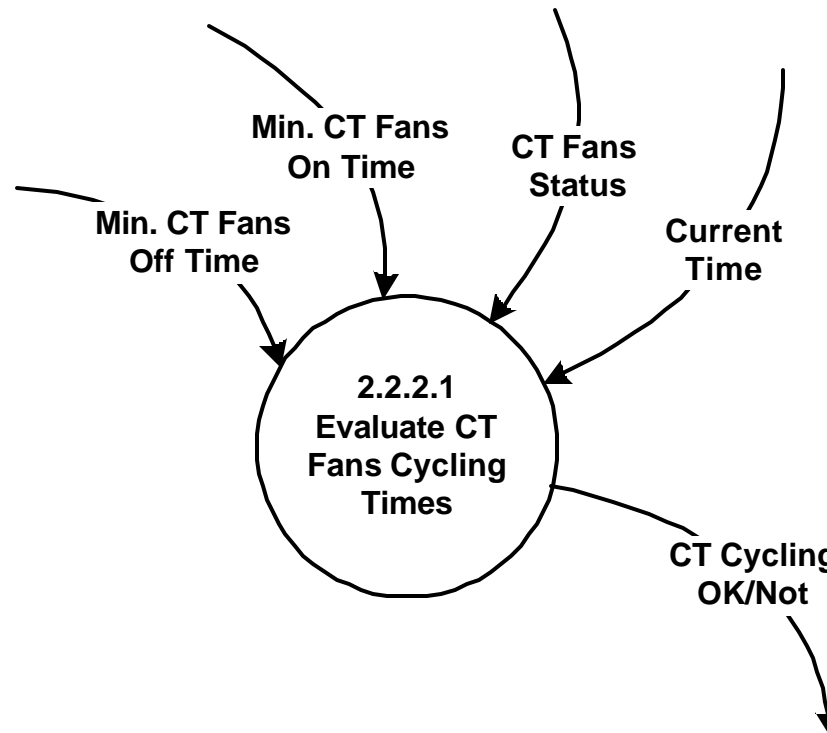

Automated Diagnostics	Version: 1.1
Software Requirements Specification	Date: 8/28/2003
Software Requirements Specification 1-1.DOC 8/29/2003	

### 2.2.2.1 Evaluate CT Fans Cycling Times

Determine if new cycling information is available to analyze (fans currently on).

If CT Fans Status = "On" and Last CT Fans Status = "On," then terminate this evaluation. There is nothing new to check.

If CT Fans Status = "On" and Last CT Fans Status = "Off," then set Last CT Fans On Time = Current Time and check Last CT Fans Off Interval.

If Last CT Fans Off Interval  $\geq$  Minimum CT Fans Off Time, then CT Cycling OK/Not = "OK."

If Last CT Fans Off Interval  $<$  Minimum CT Fans Off Time, then CT Cycling OK/Not = "Not OK." The CT fans are not staying off long enough during cycling.

Possible causes include::

- The timer that is supposed to eliminate short cycling is not working properly.
- The "on" and "off" control setpoints for the fans are too close to one another.

Possible corrective actions include:

- Check the control algorithm for the fans if it is controlled by software. Increase the minimum off time in the software, as necessary, to meet the manufacturers specification for minimum off time.
- Check the performance of the time-delay relay. Energize the relay and manually time the delay until action.
- Compare the measured time with the specification. Replace or adjust the relay if it is out of spec.

Determine if new cycling information is available to analyze (fans currently off).

If CT Fans Status = "Off" and Last CT Fans Status = "Off," then terminate this evaluation. There is nothing new to check.

If CT Fans Status = "Off" and the Last CT Fans Status = "On," then set Last CT Fans Off Time = Current Time and check Last Fan On Interval.

If Last CT Fans On Interval  $\geq$  Minimum CT Fans On Time, then CT Cycling OK/Not = "OK."

If Last CT Fans On Interval  $<$  Minimum CT Fans On Time, then CT Cycling OK/Not = "Not OK." The CT fans are not staying on long enough during cycling.

Possible causes include:

- The timer that is supposed to eliminate short cycling is not working properly.
- The "on" and "off" control setpoints for the fans are too close to one another.
- The cooling tower capacity is too great for the load, so the fans rapidly cycle off (i.e., the on time is very short) because the load is met quickly.

Possible corrective actions include:

- Check the control algorithm for the fans if it is controlled by software. Increase the minimum off time in the software, as necessary, to meet the manufacturers specification for minimum off time.
- Check the performance of the time-delay relay. Energize the relay and manually time the delay until action.
- Compare the measured time with the specification. Replace or adjust the relay if it is out of spec.

Automated Diagnostics	Version: 1.1
Software Requirements Specification	Date: 8/28/2003
Software Requirements Specification 1-1.DOC 8/29/2003	

## 2.2.3 Diagnose CT Based on Approach

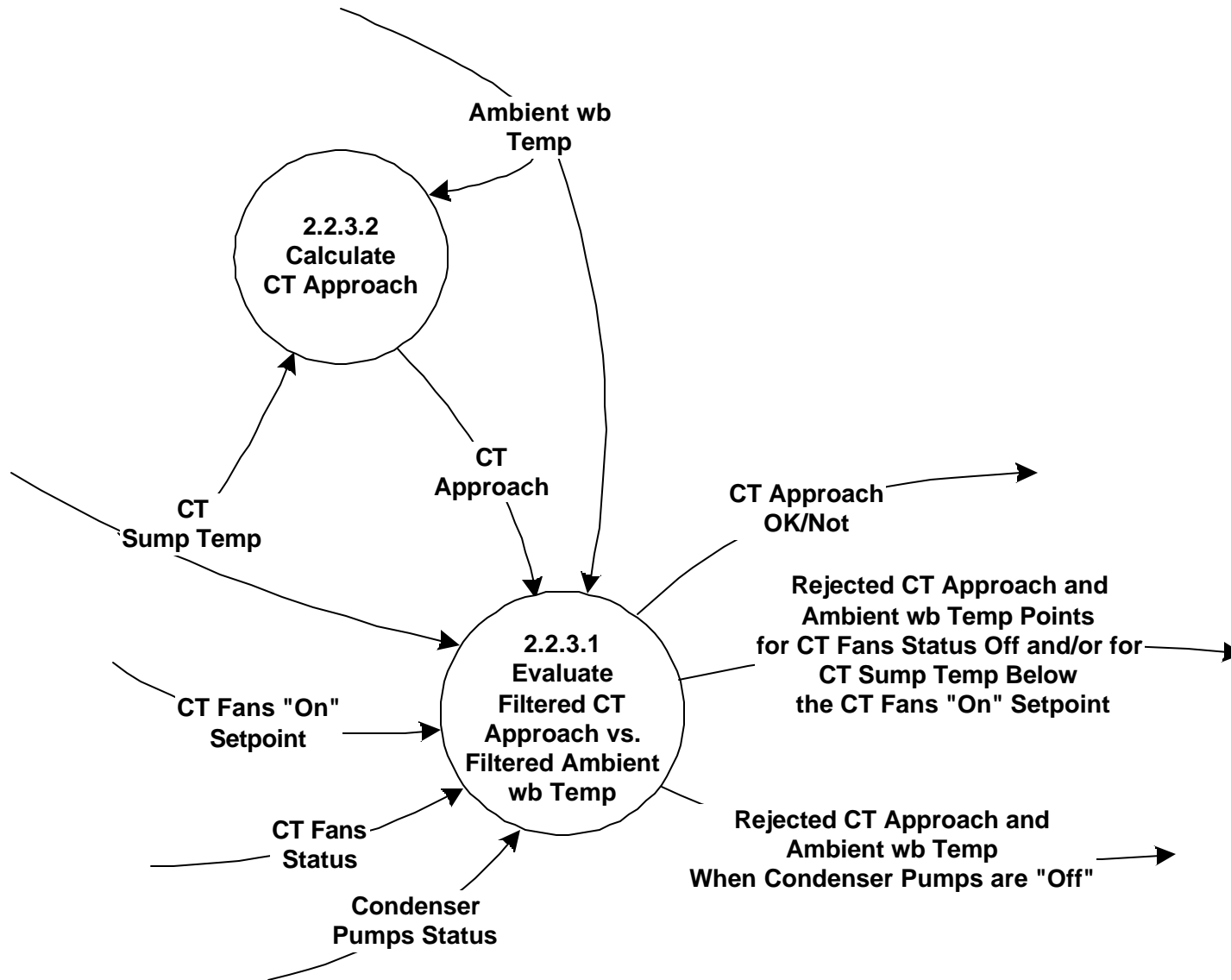

Automated Diagnostics	Version: 1.1
Software Requirements Specification	Date: 8/28/2003
Software Requirements Specification 1-1.DOC 8/29/2003	

### 2.2.3.1 Evaluate Filtered CT Approach vs. Filtered Ambient wb Temp

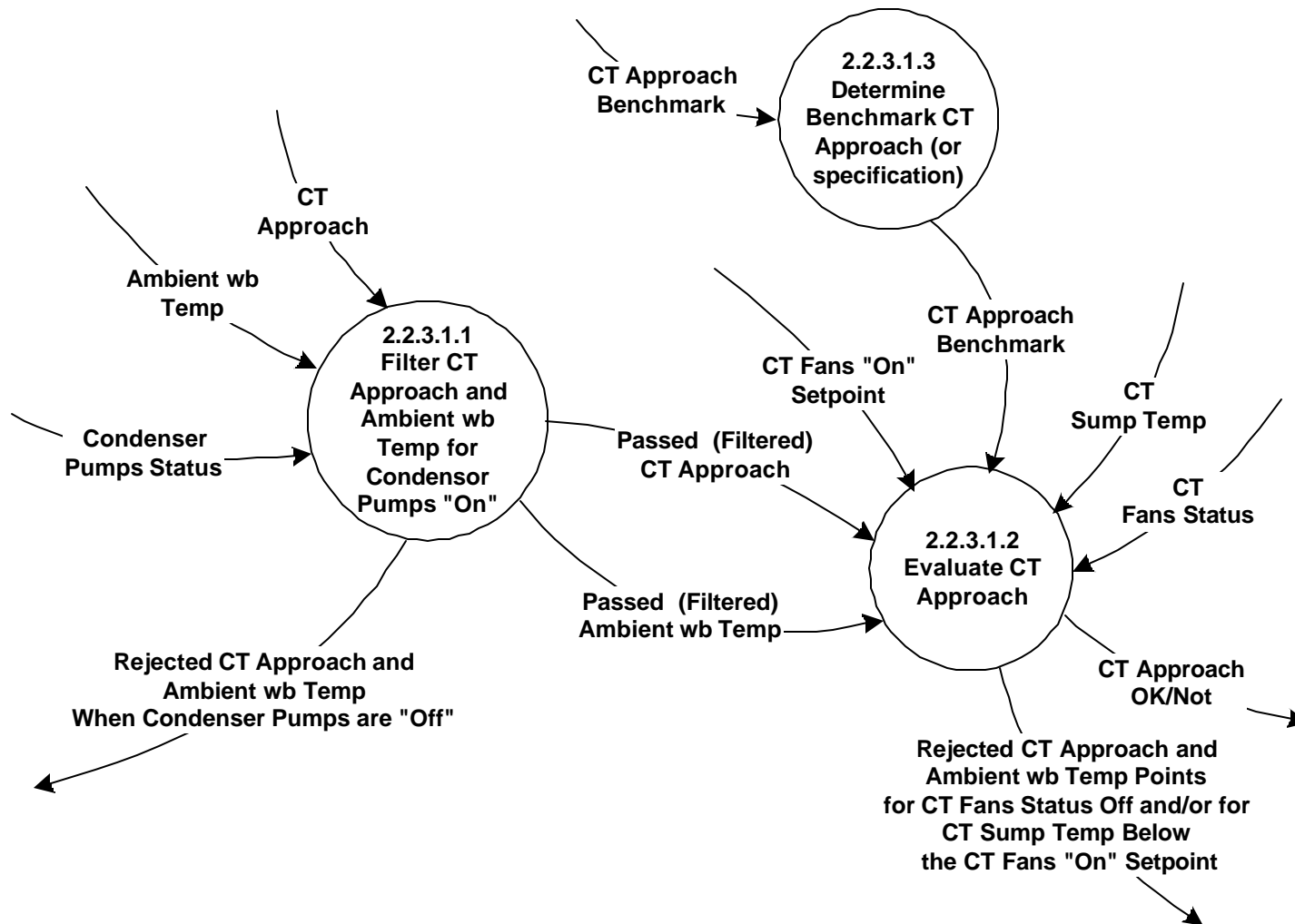



Automated Diagnostics	Version: 1.1
Software Requirements Specification	Date: 8/28/2003
Software Requirements Specification 1-1.DOC 8/29/2003	

### **2.2.3.1.1 Filter CT Approach and Ambient wb Temp for Condenser Pumps "On"**

For each triplet of (Condenser Pumps Status, CT Approach, and Ambient wb Temperature)

- reject (i.e., filter out) those triplets for which Condenser Pumps Status = off.
- pass those triplets for which Condenser Pumps Status = on.

Automated Diagnostics	Version: 1.1
Software Requirements Specification	Date: 8/28/2003
Software Requirements Specification 1-1.DOC 8/29/2003	

## 2.2.3.1.2 Evaluate CT Approach Behavior

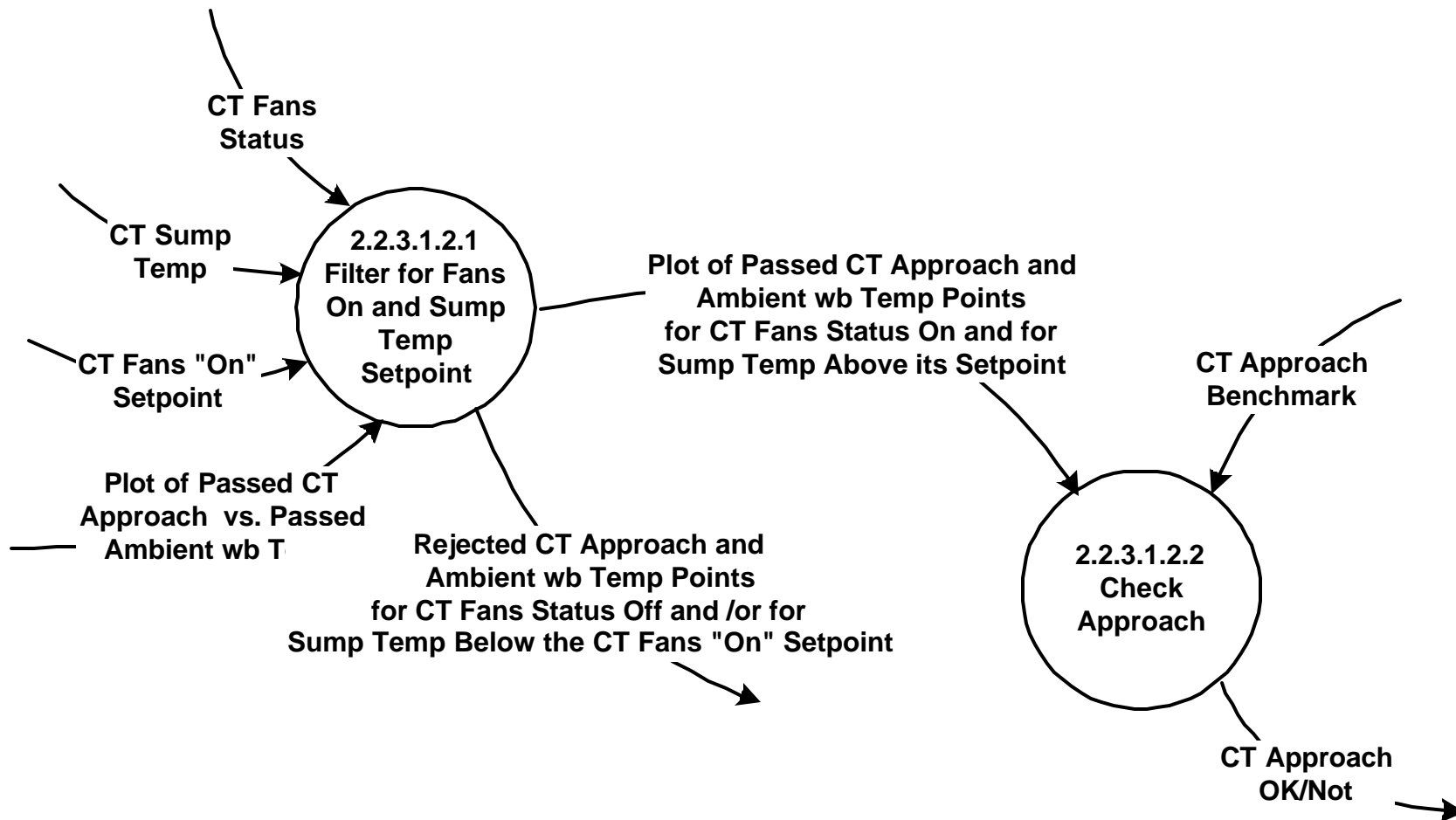

Automated Diagnostics	Version: 1.1
Software Requirements Specification	Date: 8/28/2003
Software Requirements Specification 1-1.DOC 8/29/2003	

### **2.2.3.1.2.1 Filter for Fans "On" and Sump Temp Setpoint**

For each point on the Plot of filtered CT Approach vs. Filtered Ambient wb Temp,  
reject it

- if the CT Fans Status is "off" or
- if the Sump Temperature < CT Fans "on" setpoint

otherwise, accept it (pass it).

Ref: 2.4 approach diagnostics discussion.doc

Automated Diagnostics	Version: 1.1
Software Requirements Specification	Date: 8/28/2003
Software Requirements Specification 1-1.DOC 8/29/2003	

## 2.2.3.1.2.2 Check Approach

Compare values of CT Approach to the CT Approach Benchmark.

If CT Approach is  $\leq$  CT Approach Benchmark, then set CT Approach OK/Not = "OK"

If CT Approach is  $>$  CT Approach Benchmark, then there is a problem (not OK) with CT heat rejection. Set CT Approach OK/Not = "Not OK. There is a problem with heat rejection from the cooling tower."

Possible causes of heat rejection degradation (i.e., CT Approach OK/Not = Not OK):

Cooling tower media fouled due to mineral deposits or ambient dirt/dust/etc. Need to inspect.

Restricted airflow for other reasons (e.g., piece of cardboard stuck over part of cooling tower air inlet)

Condenser pump fouling, pipe fouling, or other restrictions on the water side.

Ref. File: 2.4 Approach diagnostics discussion.doc

Automated Diagnostics	Version: 1.1
Software Requirements Specification	Date: 8/28/2003
Software Requirements Specification 1-1.DOC 8/29/2003	

### **2.2.3.1.3 Determine Benchmark CT Approach**

CT Approach Benchmark is a user input (in the current process; see note below).

Automated Diagnostics	Version: 1.1
Software Requirements Specification	Date: 8/28/2003
Software Requirements Specification 1-1.DOC 8/29/2003	

## 2.2.3.2 Calculate CT Approach

For each pair of values of Sump Temperature and Ambient wb Temperature corresponding to the same time, calculate the CT Approach using

$$\text{CT Approach} = \text{Sump Temp} - \text{Ambient Wet Bulb Temp}$$

Note: Approach is not "controlled" - it is the difference between the sump temperature, which IS controlled, and the ambient wb temperature, which is NOT controlled.

Ref: 2.4 approach diagnostics.doc

Automated Diagnostics	Version: 1.1
Software Requirements Specification	Date: 8/28/2003
Software Requirements Specification 1-1.DOC 8/29/2003	

## 2.3 Diagnose Cooling Tower Capacity

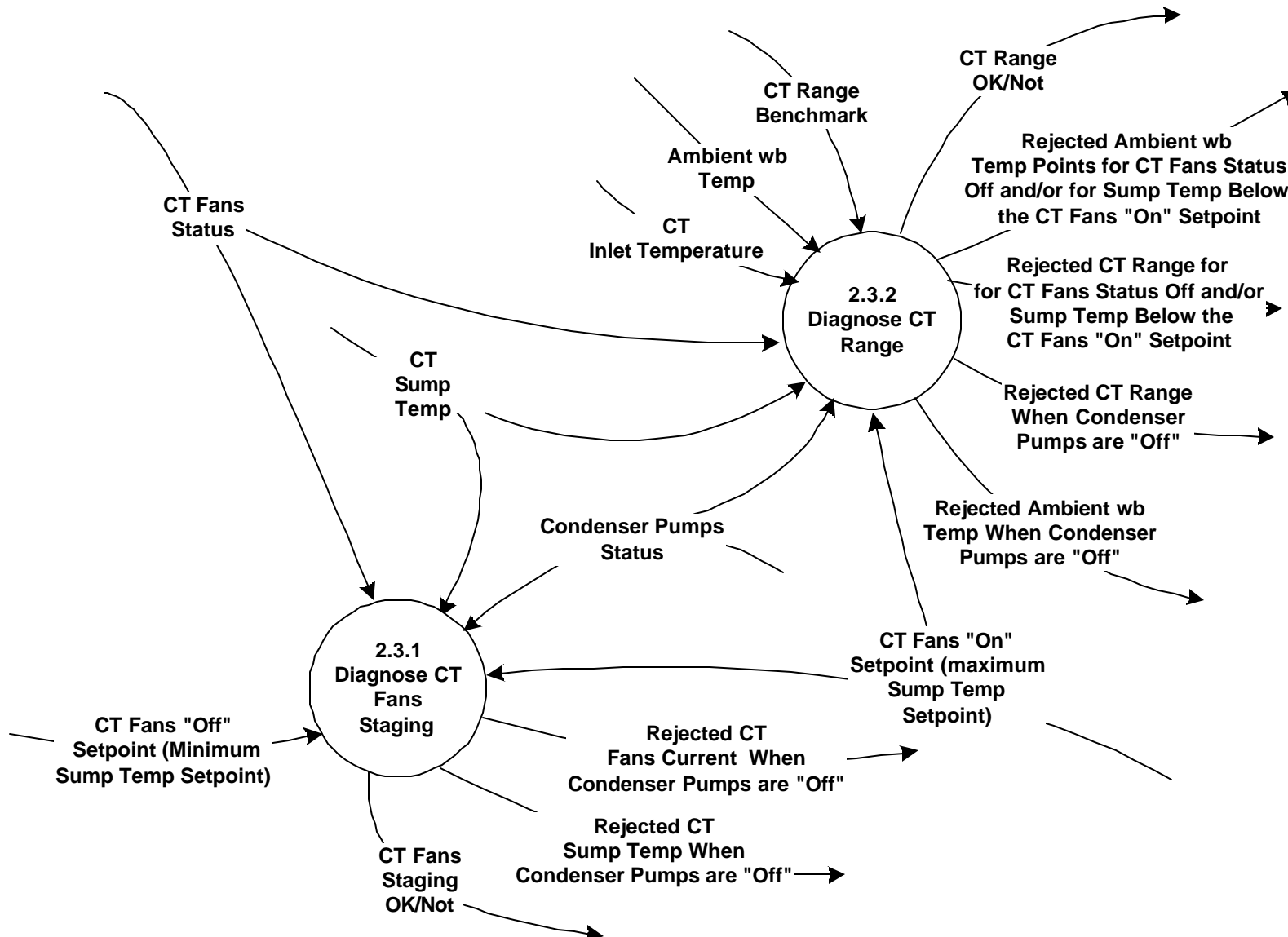

Automated Diagnostics	Version: 1.1
Software Requirements Specification	Date: 8/28/2003
Software Requirements Specification 1-1.DOC 8/29/2003	

## 2.3.1 Diagnose CT Fans Staging

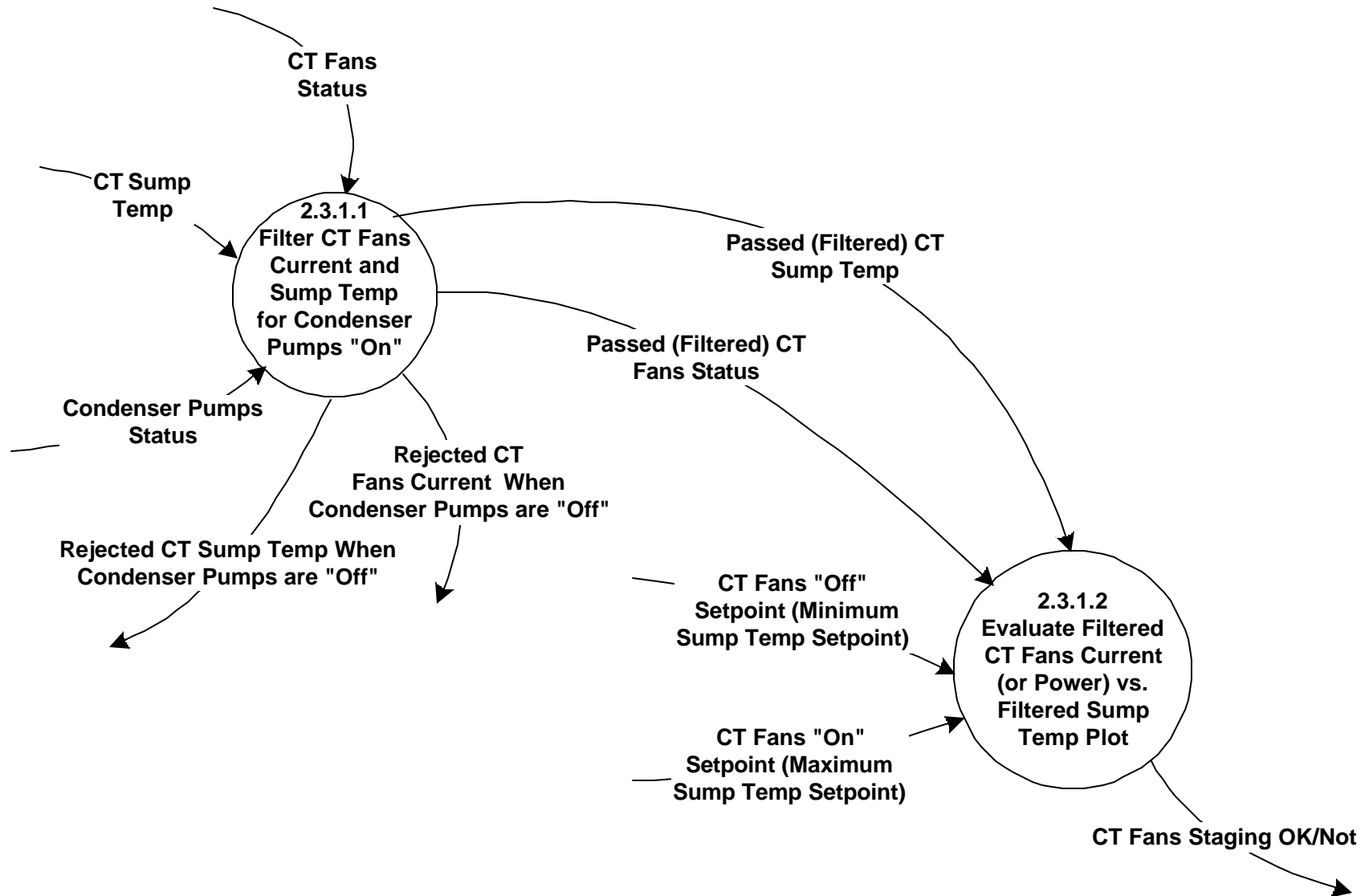



Automated Diagnostics	Version: 1.1
Software Requirements Specification	Date: 8/28/2003
Software Requirements Specification 1-1.DOC 8/29/2003	

### **2.3.1.1 Filter CT Fans Current and Sump Temp for CT Pumps "On"**

For each triplet of (Condenser Pumps Status, CT Fans Status, and CT Sump Temperature) reject (i.e., filter out) those triplets for which Condenser Pumps Status = off.  
pass those triplets for which Condenser Pumps status = on.

Automated Diagnostics	Version: 1.1
Software Requirements Specification	Date: 8/28/2003
Software Requirements Specification 1-1.DOC 8/29/2003	

### 2.3.1.2 Evaluate Filtered CT Fans Current (or Power) vs. Filtered Sump Temp Plot

Compare Sump Temperature to the CT Fans "On" Setpoint (maximum Sump Temperature Setpoint).

If Tsump < CT Fans "On" Setpoint, then set Fans Staging OK/Not = "OK (as far as we can tell)"

If Tsump > CT Fans "On" Setpoint, and CT Fans Status = "On" for all CT fans, then set Fans Staging OK/Not = "OK."

If Tsump > CT Fans "On" Setpoint and CT Fans Status <sup>1</sup> "On" for all CT fans (i.e., all CT fans are not on), set Fans Staging OK/Not = "not OK. There is a fan staging problem and the cooling tower is not maintaining the Sump Temp as low as it could/should."

Compare Tsump to the CT Fans "Off" Setpoint (minimum Sump Temperature Setpoint).

If Tsump > CT Fans "Off" Setpoint, then set Fans Staging OK/Not = "OK (as far as we can tell)."

If Tsump < CT Fans "Off" Setpoint, and if CT Fans Status = "Off" for all CT Fans (i.e., all CT fans are off), then set Fans Staging OK/Not = "OK."

If Tsump < CT Fans "Off" Setpoint, and If any CT Fans Status = "On" (i.e., any CT fan is "on"), then set Fans Staging OK/Not = "Not OK. There is a fan staging problem and energy is being wasted. All CT Fans should be off."

Note:

The minimum and maximum sump temp setpoints are currently specified as inputs. A procedure could be developed to derive them from performance data. This would reduce the number of user inputs required.

Note: A process for checking the individual fan stages has not been specified here. it would need to be added. See Behavior 3 in the reference file.

Tsump = Sump Temp

Tsump maximum setpoint = maximum Sump Temperature setpoint

Tsump minimum setpoint = minimum Sump Temperature setpoint

Ref. File: 3.3 fan staging diagnostic.doc

Automated Diagnostics	Version: 1.1
Software Requirements Specification	Date: 8/28/2003
Software Requirements Specification 1-1.DOC 8/29/2003	

### 2.3.2 Diagnose CT Range

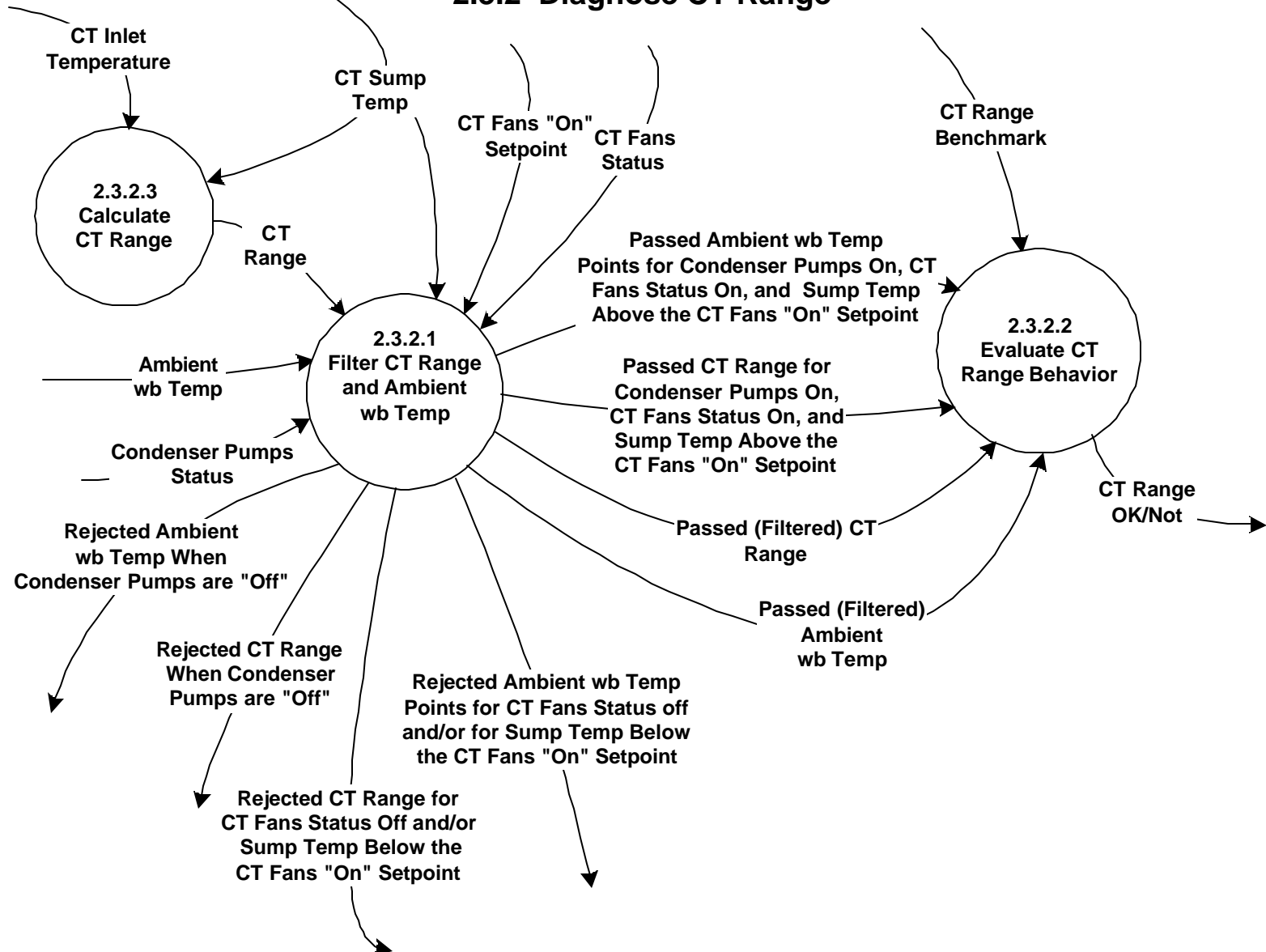

Automated Diagnostics	Version: 1.1
Software Requirements Specification	Date: 8/28/2003
Software Requirements Specification 1-1.DOC 8/29/2003	

### 2.3.2.1 Filter CT Range and Ambient wb Temp

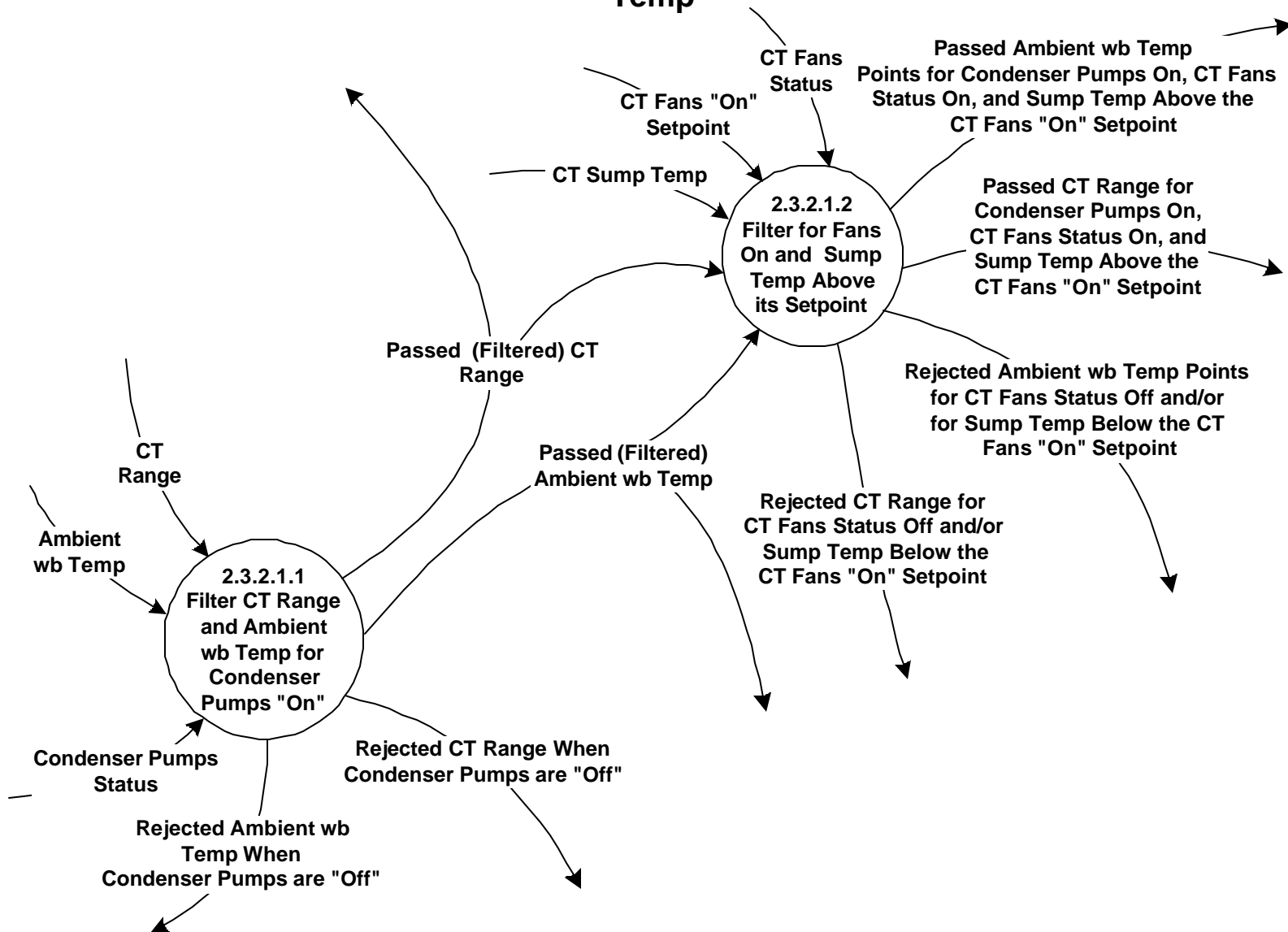

Automated Diagnostics	Version: 1.1
Software Requirements Specification	Date: 8/28/2003
Software Requirements Specification 1-1.DOC 8/29/2003	

### **2.3.2.1.1 Filter CT Range and Ambient wb Temp for Condenser Pumps "On"**

For each triplet of (Condenser Pumps Status, CT Range, and Ambient wb Temperature)  
reject (i.e., filter out) those triplets for which Condenser Pumps Status = off.  
pass those triplets for which Condenser Pumps status = on.

Automated Diagnostics	Version: 1.1
Software Requirements Specification	Date: 8/28/2003
Software Requirements Specification 1-1.DOC 8/29/2003	

### **2.3.2.1.2 Filter for Fans "On" and Sump-Temp Setpoint**

For each point on the Plot of filtered CT Range vs. Filtered Ambient wb Temp, reject it

if the Fans Status is "off" or

if the Sump Temperature is below the CT Fans "On" Setpoint (Maximum Sump Temperature Setpoint).

otherwise, accept it (pass it).

Automated Diagnostics	Version: 1.1
Software Requirements Specification	Date: 8/28/2003
Software Requirements Specification 1-1.DOC 8/29/2003	

## 2.3.2.2 Evaluate CT Range Behavior

Compare values of CT Range to the Range Benchmark..

If CT Range is  $\geq$  Range Benchmark, then set CT Range OK/Not= "OK"

If CT Range is  $<$  Range Benchmark, then set CT Range OK/Not = "Not OK. There is a problem with CT heat rejection and it is performing at less than expected capacity."

Possible heat rejection degradation causes:

Tower media fouling due to mineral deposits or ambient dirt/dust/etc.

Restricted airflow

Condenser pump fouling, again, pipe fouling, restrictions

Tower too small for load (design problem)

Ref. File: 3.2.3 Range diagnostics discussion.doc

Automated Diagnostics	Version: 1.1
Software Requirements Specification	Date: 8/28/2003
Software Requirements Specification 1-1.DOC 8/29/2003	

### 2.3.2.3 Calculate CT Range

For each time increment (and pair of necessary temperature values), calculate the CT Range, using the formula

$$\text{CT Range} = \text{CT Sump Temperature} - \text{CT Inlet Temperature.}$$



Automated Diagnostics	Version: 1.1
Software Requirements Specification	Date: 8/28/2003
Software Requirements Specification 1-1.DOC 8/29/2003	

### 3.0 Determine Equipment Status

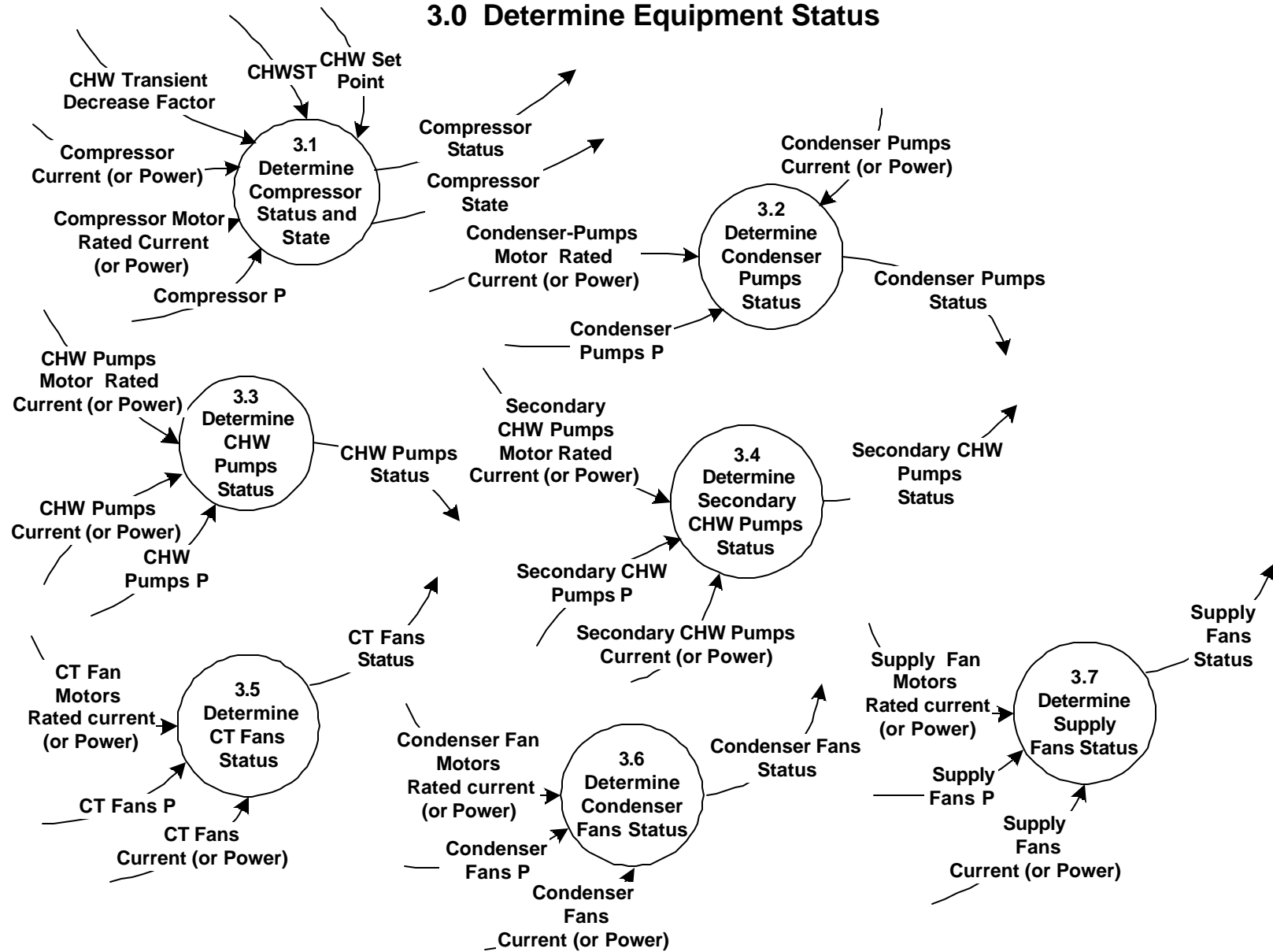

Automated Diagnostics	Version: 1.1
Software Requirements Specification	Date: 8/28/2003
Software Requirements Specification 1-1.DOC 8/29/2003	

### 3.1 Determine Compressor Status and State

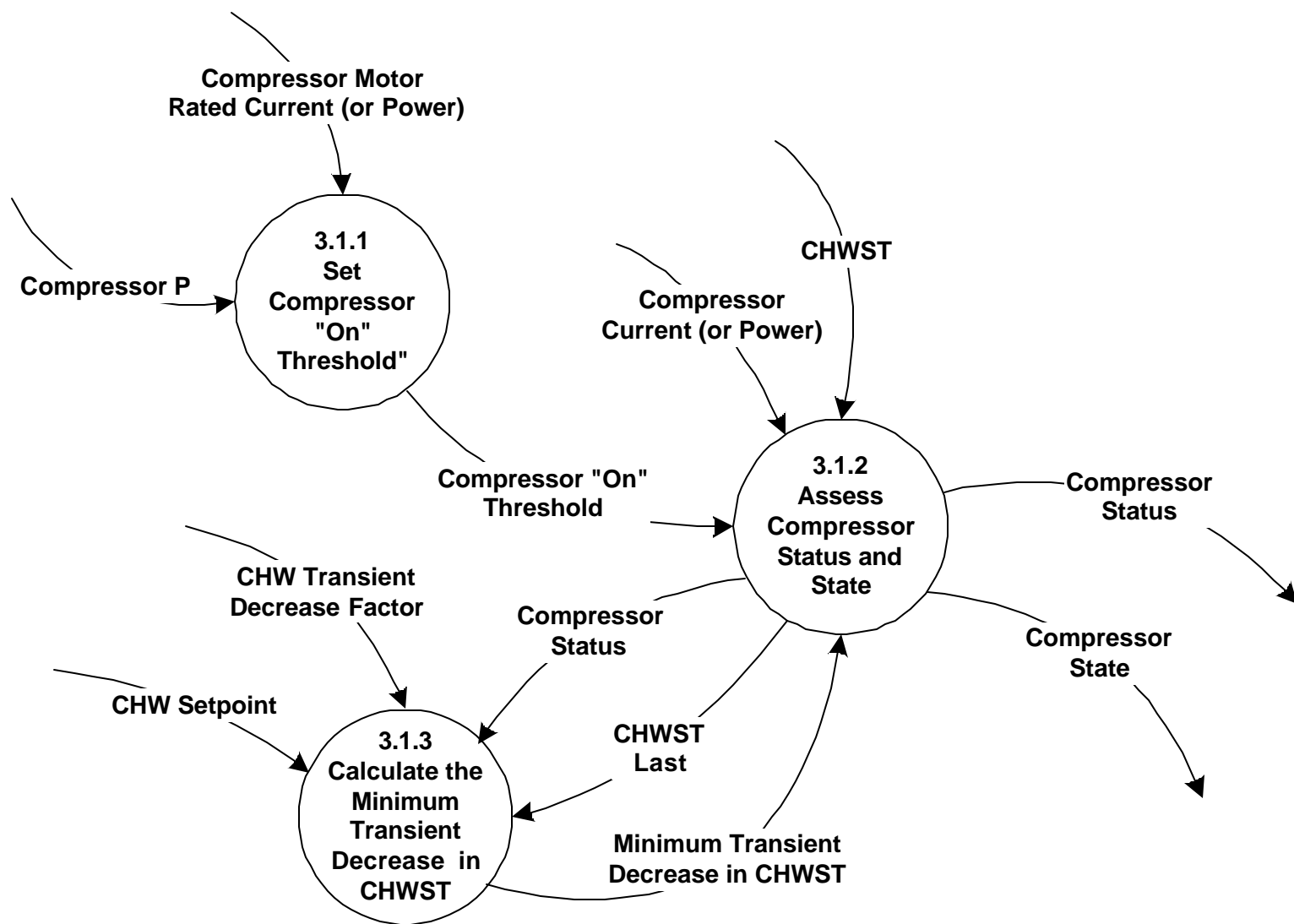

Automated Diagnostics	Version: 1.1
Software Requirements Specification	Date: 8/28/2003
Software Requirements Specification 1-1.DOC 8/29/2003	

### 3.1.1 Set Compressor "On" Threshold

Calculate the Compressor "On" Threshold using

$$\text{Compressor "On" Threshold} = \text{Compressor P} \times \text{Compressor Motor Rated Current (or Power)}$$

Notes:

The chiller is "on" when the compressor is "on;" therefore, the chiller status can be determined by evaluating the compressor on/off status. As the result, the Chiller "On" Threshold is set by setting the Compressor "On" threshold.

The Compressor "On" Threshold is calculated from input power rating of the compressor motor.

Compressor P has values that range from 10 to 50% -- this can be a user input.

Ref file: 2.1CHW temperature control.doc

Automated Diagnostics	Version: 1.1
Software Requirements Specification	Date: 8/28/2003
Software Requirements Specification 1-1.DOC 8/29/2003	

### 3.1.2 Assess Compressor Status and State

For each value of Compressor Current (or Power),  
 compare Compressor Current (or Power) to the Compressor "On" Threshold.  
 If the value of Compressor Current (or Power) <= Compressor "On" Threshold, then set Compressor Status = "Off" and set Compressor State = "Off"  
 If the value of Compressor Current (or Power) > Compressor "On" Threshold, then set Compressor Status = "on."

If Compressor Status = "On", then evaluate Compressor State as follows:  
 Update the value of Last Compressor State, using

Last Compressor State = Compressor State.

Determine and assign the new value of Compressor State for the current time

Check if the compressor is already in steady state

If Last Compressor State = Steady,  
 then set Compressor State = "Steady"

If Compressor Status = "On" and the Last Compressor State = "Transient", then  
 Calculate Drop in CHW Supply Temperature using

$\text{Drop in CHWST} = \text{CHWST Last} - \text{CHWST}$

Compare Drop in CHW Supply Temperature to the Minimum Transient Decrease in CHWST.

If Drop in CHWST > Minimum Transient Decrease in CHWST, then set Compressor State = "Transient".

If Drop in CHWST <= Minimum Transient Decrease in CHWST, then set Compressor State = "Steady"

Update CHWST Last  
 CHWST Last = CHWST

Note: Compressor Status = Chiller Status

Automated Diagnostics	Version: 1.1
Software Requirements Specification	Date: 8/28/2003
Software Requirements Specification 1-1.DOC 8/29/2003	

### 3.1.3 Calculate the Minimum Transient Decrease in CHWST

Calculate the Minimum Transient Decrease in CHWST using the relation:

$$\text{Minimum Transient Decrease in CHWST} = \text{CHW Transient Decrease Factor} * (\text{CHWST at Last Time Off} - \text{CHWST Setpoint})$$

Set new value of CHWST at Last Time Off,

If Compressor Status = "Off" and Last Compressor Status = "Off", then  
set CHWST at Last Time Off = CHWST

If Compressor Status = "On" and Last Compressor Status = "Off", then  
set CHWST at Last Time Off = CHWST Last

If Compressor Status = "On" and Last Compressor Status = "On" then  
set CHWST at Last Time Off = CHWST at Last Off Time (i.e., not change).

Update Last Compressor Status

$$\text{Last Compressor Status} = \text{Compressor Status}^*$$

\*This over-writes the previous compressor status with the current status and should not be performed if the previous status is required in subsequent processing.

Automated Diagnostics	Version: 1.1
Software Requirements Specification	Date: 8/28/2003
Software Requirements Specification 1-1.DOC 8/29/2003	

## 3.2 Determine Condenser Pumps Status

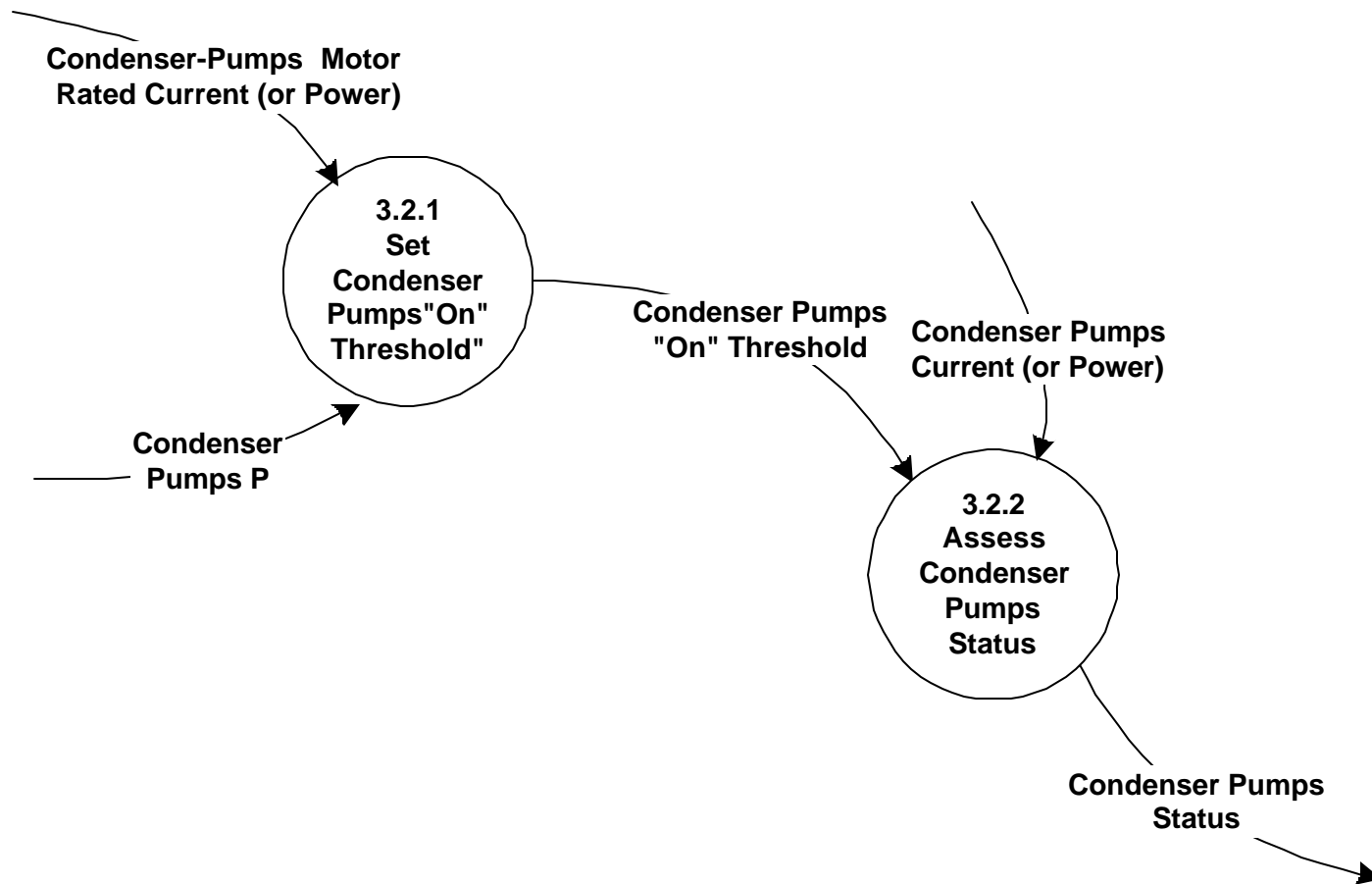

Automated Diagnostics	Version: 1.1
Software Requirements Specification	Date: 8/28/2003
Software Requirements Specification 1-1.DOC 8/29/2003	

### 3.2.1 Set Condenser Pumps "On" Threshold

Calculate the Condenser Pumps "On" Threshold using

$$\text{Condenser Pumps "On" Threshold} = \text{Condenser Pumps P} \times \text{Condenser Pump Motors Rated Current (or Power)}$$

Notes:

Condenser Pumps P has values that range from 10 to 50% -- this can be a user input.

Automated Diagnostics	Version: 1.1
Software Requirements Specification	Date: 8/28/2003
Software Requirements Specification 1-1.DOC 8/29/2003	

## 3.2.2 Assess Condenser Pumps Status

For each value of Condenser Pumps Current (or Power),  
compare Condenser Pumps Current (or Power) to the Condenser Pumps "On" Threshold.  
If the value of Condenser Pumps Current (or Power)  $\leq$  Condenser Pumps "On" Threshold, then set  
Condenser Pumps Status = "Off."  
If the value of Condenser Pumps Current (or Power)  $>$  Condenser Pumps "On" Threshold, then set  
Condenser Pumps Status = "On."



Automated Diagnostics	Version: 1.1
Software Requirements Specification	Date: 8/28/2003
Software Requirements Specification 1-1.DOC 8/29/2003	

### 3.3 Determine CHW Pumps Status

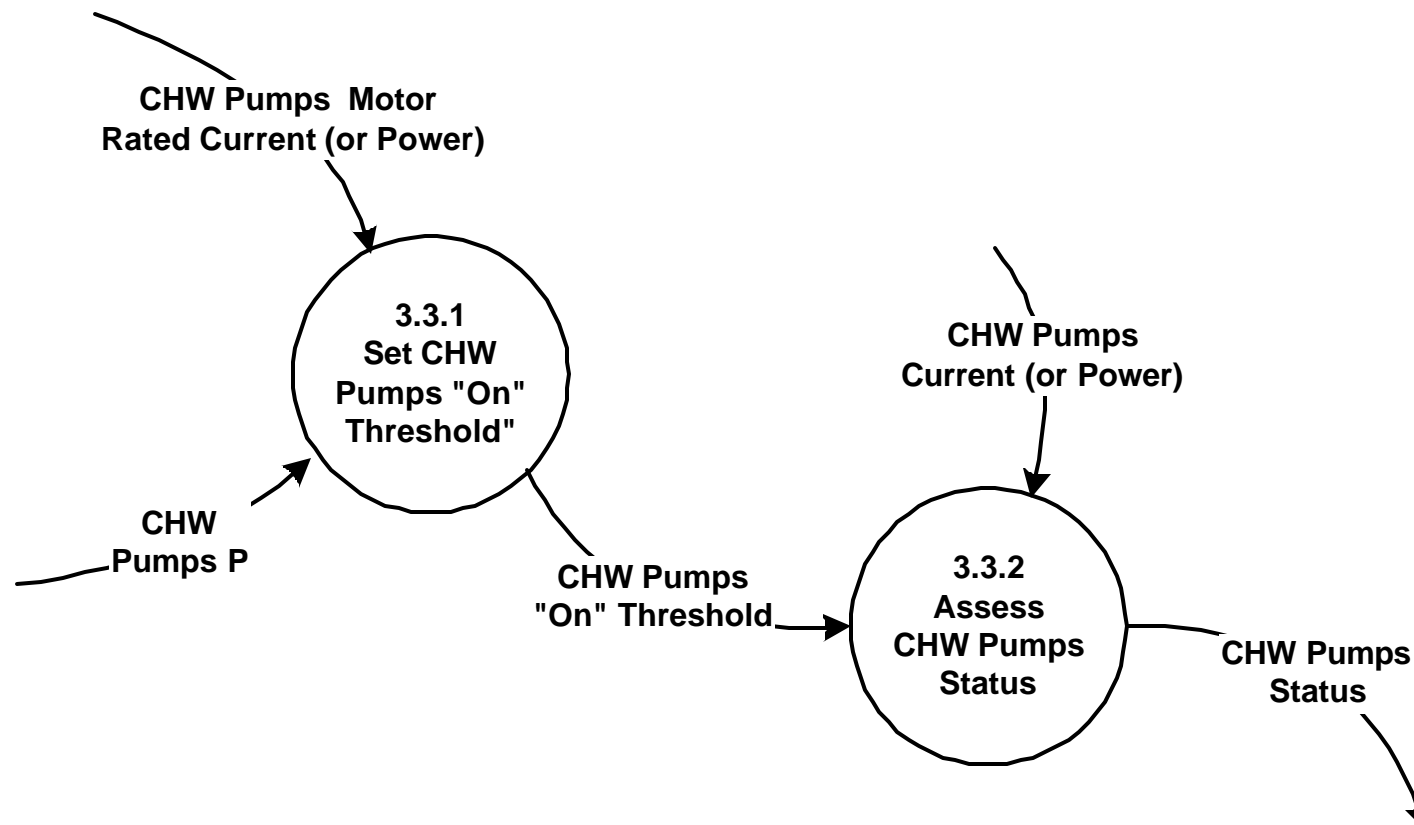

Automated Diagnostics	Version: 1.1
Software Requirements Specification	Date: 8/28/2003
Software Requirements Specification 1-1.DOC 8/29/2003	

### 3.3.1 Set CHW Pumps "On" Threshold

Calculate the CHW Pumps "On" Threshold using

$$\text{CHW Pumps "On" Threshold} = \text{CHW Pumps P} \times \text{CHW Pumps Motor Rated Current (or Power)}$$

Notes:

CHW Pumps P has values that range from 10 to 50% -- this can be a user input.

Automated Diagnostics	Version: 1.1
Software Requirements Specification	Date: 8/28/2003
Software Requirements Specification 1-1.DOC 8/29/2003	

### 3.3.2 Assess CHW Pumps Status

For each value of CHW Pumps Current (or Power),  
compare CHW Pumps Current (or Power) to the CHW Pumps "On" Threshold.  
If the value of CHW Pumps Current (or Power)  $\leq$  CHW Pumps "On" Threshold, then set  
CHW Pumps Status = "off."  
If the value of CHW Pumps Current (or Power)  $>$  CHW Pumps "On" Threshold, then set CHW  
Pumps Status = "On."

Automated Diagnostics	Version: 1.1
Software Requirements Specification	Date: 8/28/2003
Software Requirements Specification 1-1.DOC 8/29/2003	

### 3.4 Determine Secondary CHW Pumps Status

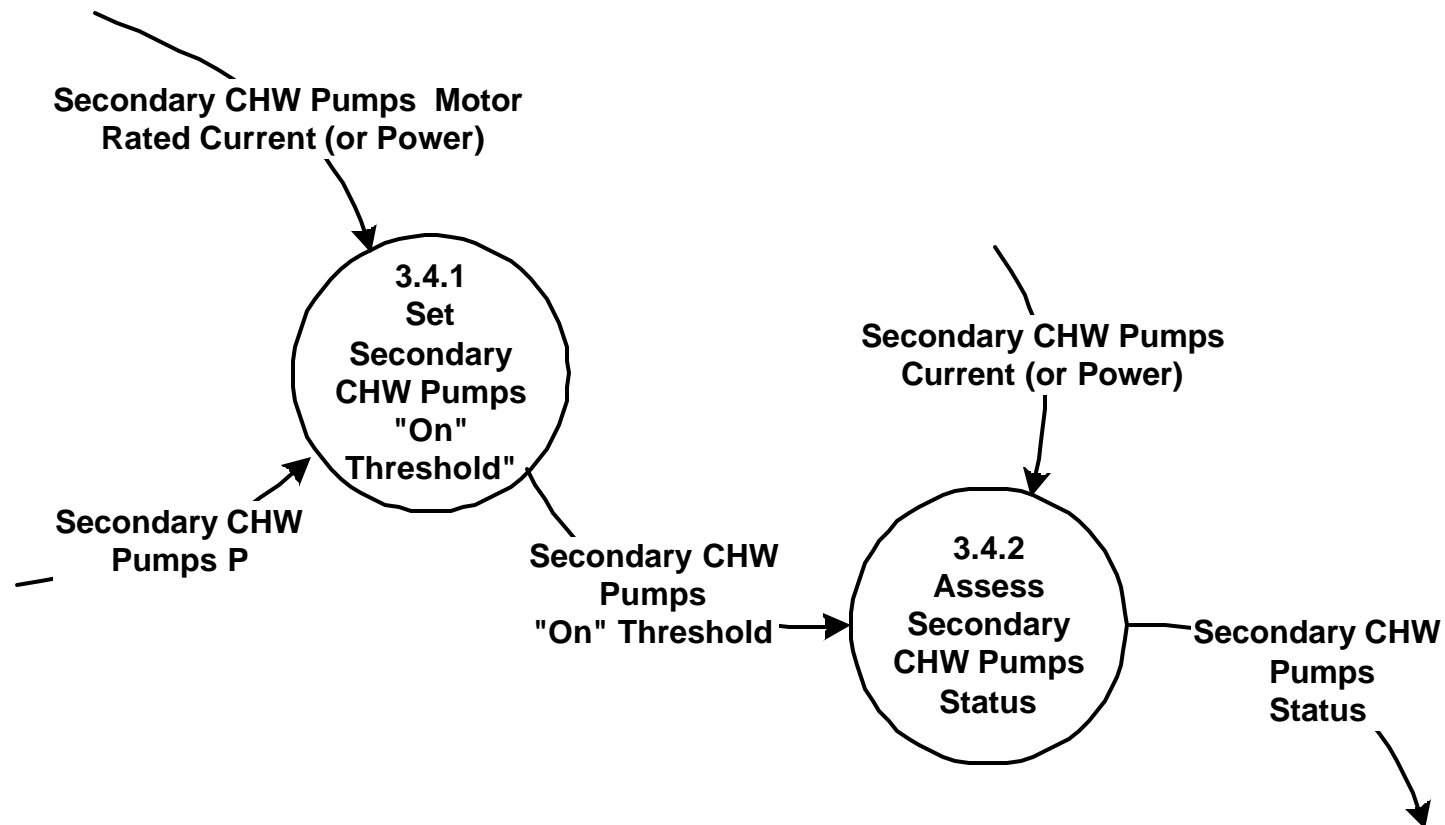

Automated Diagnostics	Version: 1.1
Software Requirements Specification	Date: 8/28/2003
Software Requirements Specification 1-1.DOC 8/29/2003	

### **3.4.1 Set Secondary CHW Pumps "On" Threshold"**

Calculate the Secondary CHW Pumps "On" Threshold using

$$\text{Secondary CHW Pumps "On" Threshold} = \text{Secondary CHW Pumps P} \times \text{Secondary CHW Pumps Motors Rated Current (or Power)}$$

Notes:

Secondary CHW Pumps P has values that range from 10 to 50% -- this can be a user input.

Automated Diagnostics	Version: 1.1
Software Requirements Specification	Date: 8/28/2003
Software Requirements Specification 1-1.DOC 8/29/2003	

### 3.4.2 Assess Secondary CHW Pumps Status

For each value of Secondary CHW Pumps Current (or Power),  
compare Secondary CHW Pumps Current (or Power) to the Secondary CHW Pumps "On" Threshold.  
If the value of Secondary CHW Pumps Current (or Power)  $\leq$  Secondary CHW Pumps "On" Threshold, then set Secondary CHW Pumps Status = "off."  
  
If the value of Secondary CHW Pumps Current (or Power)  $>$  Secondary CHW Pumps "On" Threshold, then set Secondary CHW Pumps Status = "On."

Automated Diagnostics	Version: 1.1
Software Requirements Specification	Date: 8/28/2003
Software Requirements Specification 1-1.DOC 8/29/2003	

### 3.5 Determine CT Fans Status

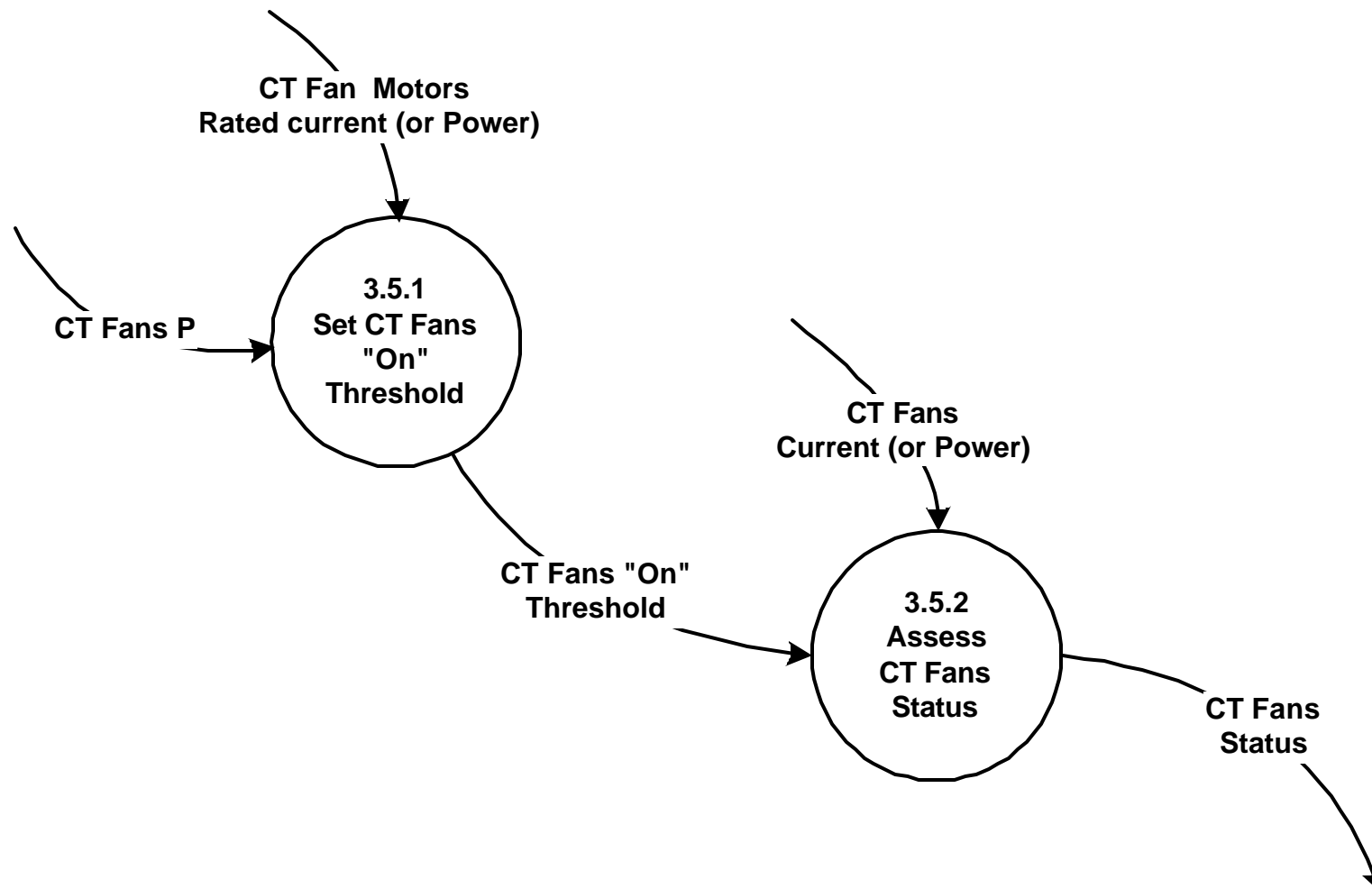

Automated Diagnostics	Version: 1.1
Software Requirements Specification	Date: 8/28/2003
Software Requirements Specification 1-1.DOC 8/29/2003	

### 3.5.1 Set CT Fans "On" Threshold

Calculate the CT Fans "On" Threshold using

$$\text{CT Fans "On" Threshold} = \text{CT Fans P} \times \text{CT Fan Motors Rated Current (or Power)}$$

Notes:

CT Fans P has values that range from 10 to 50% -- this can be a user input.



Automated Diagnostics	Version: 1.1
Software Requirements Specification	Date: 8/28/2003
Software Requirements Specification 1-1.DOC 8/29/2003	

## 3.5.2 Assess CT Fans Status

For each value of CT Fans Current (or Power),  
compare CT Fans Current (or Power) to the CT Fans "On" Threshold.  
If the value of CT Fans Current (or Power)  $\leq$  CT Fans "On" Threshold, then set CT Fans Status = "Off."  
  
If the value of CT Fans Current (or Power)  $>$  CT Fans "On" Threshold, then set CT Fans Status = "On."

Note:

Automated Diagnostics	Version: 1.1
Software Requirements Specification	Date: 8/28/2003
Software Requirements Specification 1-1.DOC 8/29/2003	

### 3.6 Determine Condenser Fans Status

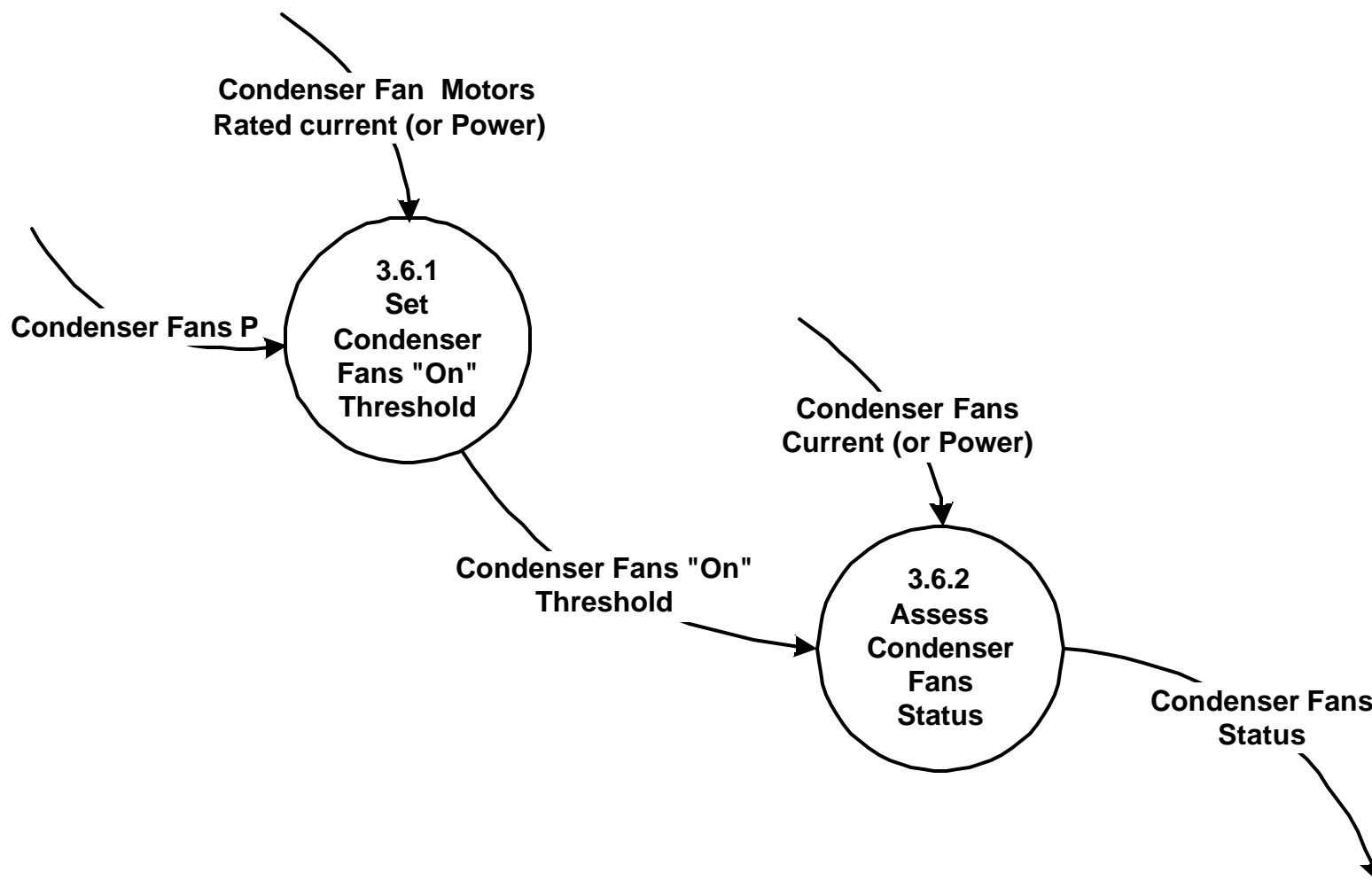

Automated Diagnostics	Version: 1.1
Software Requirements Specification	Date: 8/28/2003
Software Requirements Specification 1-1.DOC 8/29/2003	

### 3.6.1 Set Condenser Fans "On" Threshold

Calculate the Condenser Fans "On" Threshold using

$$\text{Condenser Fans "On" Threshold} = \text{Condenser Fans P} \times \text{Condenser Fan Motors Rated Current (or Power)}$$

Notes:

Condenser Fans P has values that range from 10 to 50% -- this can be a user input.

Automated Diagnostics	Version: 1.1
Software Requirements Specification	Date: 8/28/2003
Software Requirements Specification 1-1.DOC 8/29/2003	

## 3.6.2 Assess Condenser Fans Status

For each value of Condenser Fans Current (or Power),  
compare Condenser Fans Current (or Power) to the Condenser Fans "On" Threshold.  
If the value of Condenser Fans Current (or Power)  $\leq$  Condenser Fans "On" Threshold, then set  
Condenser Fans Status = "Off."  
  
If the value of Condenser Fans Current (or Power)  $>$  Condenser Fans "On" Threshold, then set  
Condenser Fans Status = "On."

Note:

Automated Diagnostics	Version: 1.1
Software Requirements Specification	Date: 8/28/2003
Software Requirements Specification 1-1.DOC 8/29/2003	

### 3.7 Determine Supply Fans Status

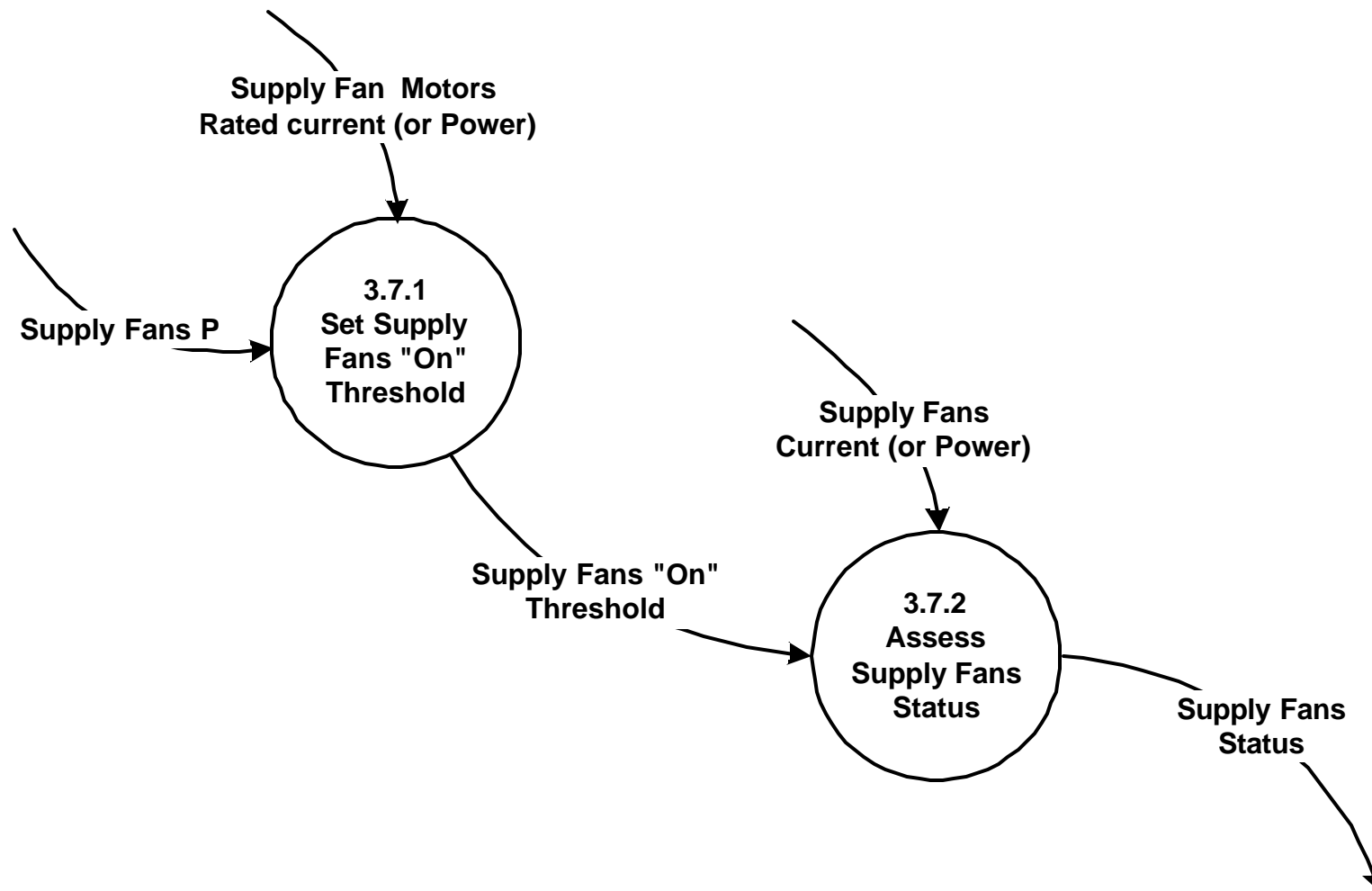

Automated Diagnostics	Version: 1.1
Software Requirements Specification	Date: 8/28/2003
Software Requirements Specification 1-1.DOC 8/29/2003	

### 3.7.1 Set Supply Fans "On" Threshold

Calculate the Supply Fans "On" Threshold using

$$\text{Supply Fans "On" Threshold} = \text{Supply Fans P} \times \text{Supply Fan Motors Rated Current (or Power)}$$

Notes:

Supply Fans P has values that range from 10 to 50% -- this can be a user input.

Automated Diagnostics	Version: 1.1
Software Requirements Specification	Date: 8/28/2003
Software Requirements Specification 1-1.DOC 8/29/2003	

## 3.7.2 Assess Supply Fans Status

For each value of Supply Fans Current (or Power),  
compare Supply Fans Current (or Power) to the Supply Fans "On" Threshold.  
If the value of Supply Fans Current (or Power)  $\leq$  Supply Fans "On" Threshold, then set  
Supply Fans Status = "Off."  
  
If the value of Supply Fans Current (or Power)  $>$  Supply Fans "On" Threshold, then set  
Supply Fans Status = "On."

Note:

Automated Diagnostics	Version: 1.1
Software Requirements Specification	Date: 8/28/2003
<document identifier>	

**5. Appendix B: Chiller, Cooling Tower, and Chilled-Water Distribution Data Dictionary**



Automated Diagnostics	Version: 1.1
Software Requirements Specification	Date: 8/28/2003
<document identifier>	

Variable	Definition	Values
<b>Ambient wb Temperature</b>	Ambient wet-bulb temperature of the outdoor air. Equivalent to the Outdoor-Air Wet-Bulb Temperature and Outdoor-Air Temperature Wet-Bulb (OATWB)	Temperature in degrees F.
<b>Ambient Wet-Bulb Temperature (OATWB)</b>	Wet-bulb temperature of the outdoor air. Equivalent to Outdoor-Air Wet-Bulb Temperature and Outdoor-Air Temperature Wet Bulb (OATWB)	Temperature in degrees F.
<b>Ambient-Air Temperature (OAT)</b>	Equivalent to Outdoor-Air Temperature (OAT) and is the dry-bulb temperature of the ambient outdoor air.	Temperature in degrees F.
<b>Chiller "On" Threshold</b>	The value of Chiller Current (or Chiller Power) above which the Chiller Status is considered "On."	On.
<b>Chiller Condenser Type</b>	The type of cooling for the chiller condenser. It takes values of "Water cooled" or "Air cooled"	Water cooled or air cooled.
<b>Chiller On/off Status</b>	An indicator of whether the chiller is on or off. Chiller on/off Status = Compressor on/off Status.	On or off.
<b>Chiller Schedule</b>	Schedule of chiller on and off times during a day. The schedule may vary based on day of week, type of day (e.g., weekday vs. weekend vs. holiday), or time of year. The schedule does not take into account chiller cycling, which may be caused by changes in load during a scheduled "on" time period.	Absolute On/off times
<b>Chiller Schedule Ok/not</b>	Indicator of whether the chiller is operating only during scheduled times or not.	Ok. Not Ok. The chiller is operating outside its scheduled time.
<b>Chiller Status</b>	Same as Chiller On/off Status. An indicator of whether the chiller is on or off. Takes values of "on" or "off." Chiller status = Compressor status.	On or off.
<b>Chiller System Type</b>	The type of chiller system. Chiller System	Water cooled or air cooled.
<b>Chiller/Compressor Start-Up Time</b>	Estimated time over which the compressor current/power spikes after the compressor is turned from off to on. This could be estimated manually and entered by the user or might be derived automatically from compressor data in a separate process (not yet specified in this model).	Time difference in minutes.

Automated Diagnostics	Version: 1.1
Software Requirements Specification	Date: 8/28/2003
<document identifier>	

Variable	Definition	Values
<b>CHWdDown</b>	The maximum temperature increment below the CHW Setpoint which when subtracted from the CHW Setpoint results in the minimum acceptably-controlled CHW Temperature.	Temperature difference in degrees F.
<b>CHWdUp</b>	The maximum temperature increment above the CHW Setpoint which when added to the CHW Setpoint results in the maximum acceptably-controlled CHW Temperature.	Temperature difference in degrees F.
<b>CHW Pumps Collective Status</b>	The status of all the primary chilled water pumps in an associated set taken as a single unit. If at least one pump of the set is ON, the collective status is ON. If all the pumps in the set are OFF, the collective status is OFF.	On or Off.
<b>CHW Pumps Current (or Power)</b>	Chilled Water Pumps Current (or Power). The measured value of current (or power) for the primary CHW pumps motor.	Current in amps.
<b>CHW Pumps Last Time Turned On</b>	Chilled Water Pumps Last Time Turned On. The time of the last measurement of CHW Water Pumps Status at which the CHW Pumps Status was "On" while the Preceding CHW Pumps Status was "Off."	Absolute time in minutes.
<b>CHW Pumps Max Start-Up Time</b>	Chilled Water Pumps Max Start-Up Time. The maximum time that the CHW Pumps should turn on before the compressor turns on. This can be set by default to 5 minutes.	Time in minutes.
<b>CHW Pumps Motor Rated Current (or Power)</b>	Chilled Water Pumps Motor Rated Current (or Power). Current (or power) rating of the primary CHW Pumps motor from the motor nameplate.	Current in amps.
<b>CHW Pumps P</b>	Chilled Water Pumps P. Fraction of Chilled Water Pumps Motor Rated Current (or Power) selected for the "On" Threshold.	None.
<b>CHW Set Point</b>	Chilled Water Set Point. The set point for the chilled water supply temperature.	Temperature in degrees F.
<b>CHWST</b>	Chilled Water Supply Temperature. Temperature of the chilled water leaving the chiller and entering the chilled water distribution system at the current time.	Temperature in degrees F.

Automated Diagnostics	Version: 1.1
Software Requirements Specification	Date: 8/28/2003
<document identifier>	

Variable	Definition	Values
<b>CHWST Alarm</b>	A variable indicating the current value of the alarm for the chilled water supply temperature deviations from set point. It takes values of "Too High", "Too Low", and "OK". It indicates whether the CHW temperature is maintained adequately over a designated minimum number of time steps (CHWST Alarm Interval High and CHWST Alarm Interval Low).	Too high, too low or Ok.
<b>CHWST Alarm Evaluation Interval</b>	The number of time steps immediately preceding the current time over which the criterion for a CHWST alarm is evaluated. This parameter takes integer values and is adjustable to change the low-alarm sensitivity. Its value may be specified as a set-up variable, default value, or empirically adjustable.	Number of time steps.
<b>CHWST Alarm Trigger High</b>	The minimum fraction of values of the variable CHWST Maintained OK/not that are equal to "Too High", when evaluated over CHWST Alarm Evaluation Interval time steps, for a high alarm to be reported, i.e., for CHWST Alarm to be set equal to "CHWST High." This variable takes values between 0.51 and 1.0 (i.e., 51% and 100%). It may be a user set-up input, a default value, or a empirically adjusted sensitivity. The current process descriptions assume that High and Low alarms cannot occur simultaneously.	Real values between 0.51 and 1.00.
<b>CHWST Alarm Trigger Low</b>	The minimum fraction of values of the variable CHWST Maintained OK/not that are equal to "Too Low", when evaluated over CHWST Alarm Evaluation Interval time steps for an alarm to be reported, i.e., for CHWST Alarm to be set equal to "CHWST Low." This variable takes values between 0.51 and 1.0 (i.e., 51% and 100%). It may be a user set-up input, a default value, or a empirically adjusted sensitivity.	Real values between 0.51 and 1.00.
<b>CHWST at Last Time Off</b>	Chilled Water Supply Temperature measured the last time the compressor was off.	Temperature in degrees F.
<b>CHWST Deviation (Chilled Water Supply Temperature Deviation)</b>	CHWST Deviation = CHW Temperature - CHW Setpoint. The amount by which the actual Chilled Water Supply Temperature deviates from the chilled water set point at the present time.	Temperature difference in degrees F.

Automated Diagnostics	Version: 1.1
Software Requirements Specification	Date: 8/28/2003
<document identifier>	

Variable	Definition	Values
<b><i>CHWSTFraction High</i></b>	CHWSTFraction High = CHWSTNumber High/(CHWST Alarm Evaluation Interval). This is the fraction of the total number of time steps during the CHWST Alarm Evaluation Interval that have "Too High" as the value for the variable CHWST Maintained OK/not.	Dimensionless real number between 0.0 and 1.0.
<b><i>CHWSTFraction Low</i></b>	CHWSTFraction Low = CHWSTNumber Low/(CHWST Alarm Evaluation Interval). This is the fraction of the total number of times steps during the CHWST Alarm Evaluation Interval that have "Too Low" as the value for the variable CHWST Maintained OK/not.	Dimensionless real number between 0.0 and 1.0.
<b><i>CHWST Last</i></b>	The value of the Chilled Water Supply Temperature (CHWST) corresponding to the last measurement time immediately preceding the current measurement time.	Temperature in degrees F.
<b><i>CHWST Lower Bound</i></b>	Chilled Water Supply Temperature Lower Bound = CHW Setpoint - (CHWdDown). It is the minimum CHW temperature considered acceptably controlled.	Temperature difference in degrees F.
<b><i>CHWST Maintained OK/not (Chilled Water Supply Temperature Maintained OK/not)</i></b>	Chilled Water Supply Temperature Maintained OK/not is a variable indicating whether the CHW temperature is maintained adequately at a specific point in time (i.e., time step). It takes values of: "OK," "too high," and "too low."	Ok, too high, or too low.
<b><i>CHWST Maintained OK/not Array</i></b>	The array: {CHWST Maintained OK/not, CHWST Maintained OK/not (1 time step ago), CHWST Maintained OK/not (2 time steps ago), CHWST Maintained OK/not (3 time steps ago), CHWST Maintained OK/not (4 time steps ago), CHWST Maintained OK/not [(CHWST Alarm Evaluation Interval - 1) time steps ago]}	Array with individual elements takings values of Ok or Not OK.
<b><i>CHWST Mean Too-High Deviation</i></b>	Arithmetic mean value of the CHWST Deviation for times included in the CHWST Maintained OK/not Array for which CHWST Maintained OK/not is "Too High".	Temperature in degrees F.
<b><i>CHWST Mean Too-Low Deviation</i></b>	Arithmetic mean value of the CHWST Deviation for times included in the CHWST Maintained OK/not Array for which CHWST Maintained OK/not is "Too Low".	Temperature in degrees F.
<b><i>CHWSTNumber High</i></b>	CHWSTNumber High is the number of values of the variable CHWST Maintained OK/not with values of "Too High" during the last CHWST Alarm Evaluation Interval time steps.	Integer.

Automated Diagnostics	Version: 1.1
Software Requirements Specification	Date: 8/28/2003
<document identifier>	

Variable	Definition	Values
<b>CHWSTNumber Low</b>	CHWSTNumber Low is the number of values of the variable CHWST Maintained OK/not with values of "Too Low" during the last CHWST Alarm Evaluation Interval time steps.	Integer.
<b>CHWST Upper Bound</b>	Chilled Water Supply Temperature Upper Bound = CHW Setpoint + (CHWdup). It is the maximum CHW temperature considered acceptably controlled.	Temperature in degrees F.
<b>CHW Temperature</b>	Chilled Water Temperature. Same as Chilled Water Supply Temperature.	Temperature in degrees F.
<b>CHW Transient Decrease Factor</b>	Fraction of the difference between the Chilled Water Supply Temperature (CHWST) at Last Off Time and the CHWST Setpoint that is used to determine the Minimum Transient Decrease in CHWST. It takes values between 0 and 1.0 and may be a user (setup) input, a default value, or a value determined empirically during diagnosis (i.e. use of the diagnostic tool).	Dimensionless real number between 0.0 and 1.0
<b>Compressor "On" Threshold</b>	The value of Compressor Current (or Compressor Power) above which the Compressor is considered "on." Used to determine if the chiller is "on."	Current in amps.
<b>Compressor Current (or Power)</b>	The measured value of current (or power) at the current time for the compressor motor.	Current in amps.
<b>Compressor Interlocked With CHW Pumps OK/not</b>	An indicator of whether the compressor and the CHW Pumps are properly interlocked or not. It takes values of "OK" and "Not OK."	OK Not OK.
<b>Compressor Interlock with Condenser Fans OK/Not</b>	An indicator of whether the compressor and the Condenser Fans are properly interlocked or not. It takes values of "OK" and "Not OK."	OK Not OK.
<b>Compressor Interlocked With Condenser Pumps OK/not</b>	An indicator of whether the compressor and the Condenser Pumps are properly interlocked or not. It takes values of "OK" and "Not OK."	OK Not OK.
<b>Compressor Motor Rated Current (or Power)</b>	Current (or power) rating of the compressor motor from the motor nameplate.	Current in amps.
<b>Compressor Off Cycle OK/not</b>	An indicator of whether the compressor is meeting the Minimum Compressor Off Time while cycling between off and on. It takes values of "OK" and "Not OK."	OK Not OK.

Automated Diagnostics	Version: 1.1
Software Requirements Specification	Date: 8/28/2003
<document identifier>	

Variable	Definition	Values
<b>Compressor On Cycle OK/not</b>	An indicator of whether the compressor is meeting the Minimum Compressor On Time while cycling between on and off. It takes values of "OK" and "Not OK."	OK Not OK.
<b>Compressor On/off Status</b>	Same as Compressor status. An indicator of whether the compressor is on or off. Takes values of "on" or "off." Chiller on/off Status = Compressor on/off Status.	On or off.
<b>Compressor P</b>	Fraction of Compressor Motor Rated Current (or Power) selected for the "On" Threshold	Dimensionless real number between 0.0 and 1.0.
<b>Compressor State</b>	An indicator of whether the chiller is in an off, a transient, or a steady state, where the difference between steady and transient operation is indicated by the rate of change of the chilled water supply temperature (CHWST). Takes values of "Off," "Transient," or "Steady."	Off, transient, or steady.
<b>Compressor Status</b>	Same as Compressor On/off Status. An indicator of whether the compressor (and, therefore the chiller) is on or off. Takes values of "on" or "off" as indicated by the Compressor Current. Also indicates Chiller Status, i.e., Chiller Status = Compressor Status.	On or off.
<b>Condenser Fan Motors Rated Current (or Power)</b>	Current (or power) rating of the condenser fan motors from the motor nameplates.	Current in amps.
<b>Condenser Fans P</b>	Fraction of Condenser Fan Motors Rated Current (or Power) selected for the "On" Threshold.	Dimensionless real number between 0.0 and 1.0.
<b>Condenser Fans "On" Threshold</b>	The value of Condenser Fans Current (or Power) above which the condenser fans are considered "on." Used to determine if the condenser fans are "on."	Current in amps.
<b>Condenser Fans Current (or Power)</b>	For air-cooled condensers, the measured value of current (or power) for the condenser fans	Current in amps.
<b>Condenser Fans Status</b>	For air-cooled chillers, an indicator of whether the condenser fans is (are) on or off. Takes values of "on" or "off."	On or off.
<b>Condenser Pumps P</b>	Fraction of Condenser Pump Motors Rated Current (or Power) selected for the "On" Threshold	Current in amps.

Automated Diagnostics	Version: 1.1
Software Requirements Specification	Date: 8/28/2003
<document identifier>	

Variable	Definition	Values
<b>Condenser Pumps "On" Threshold</b>	The value of Condenser Pumps Current (or Power) above which the Condenser Pumps are considered "on." Used to determine if the condenser pumps are "on."	Current in amps.
<b>Condenser Pumps Current (CPC)</b>	The measured value of the electric current to the chiller condenser pumps at the current time.	Current in amps.
<b>Condenser Pumps Current (CPC)</b>	The measured value of the electric current to the chiller condenser pumps at the current time.	Current in amps.
<b>Condenser Pumps Current (or Power)</b>	Same as CPC.	Current in amps.
<b>Condenser Pumps Last Time Turned On</b>	The time of the last measurement of Condenser Pumps Status at which the Condenser Pumps Status was "On" while the Preceding Condenser Pumps Status was "Off."	Time in minutes.
<b>Condenser Pumps Max Start-Up Time</b>	The maximum time that the condenser pumps should turn on before the compressor turns on. This can be set by default to 5 minutes.	Time in minutes.
<b>Condenser Pumps Status</b>	Variable indicating whether the condenser pumps are on or off	On or Off.
<b>Condenser Type</b>	Takes values of "water cooled" or "air cooled."	Water cooled or air cooled.
<b>Condenser-Pumps Motor Rated Current (or Power)</b>	Current (or power) rating of the condenser pumps motor from the motor nameplate.	Current in amps.
<b>CT Approach Benchmark</b>	An indicator of the maximum CT approach acceptable for the cooling tower when providing maximum cooling (i.e., when the sump temperature is at or above the setpoint and the fans running continuously). Assumed to be available as a user input based on: 1) the control specification or 2) the manufacturer's specification.	Temperature difference in degrees F.
<b>CT Cycling OK/Not</b>	Variable that indicates whether the cycling of the cooling tower fans is OK or not. If it cycles too frequently, the fan motors may be damaged reducing their lives.	OK or Not OK.

Automated Diagnostics	Version: 1.1
Software Requirements Specification	Date: 8/28/2003
<document identifier>	

Variable	Definition	Values
<b>CT Fan Motors Rated Current (or Power)</b>	Cooling Tower Fan Motors Rated Current (or Power). Current (or power) rating of the cooling tower fan motors from the motor nameplates.	Current in amps.
<b>CT Fans Current (or Power)</b>	Cooling Tower Fans Current (or Power). The measured value of the electrical current (or power) to the cooling tower fan motors at the current time.	Amps.
<b>CT Fans "On" Set Point</b>	The cooling tower "on" set point = the value of the sump temperature above which the cooling tower fans are turned on.	Temperature in degrees F.
<b>CT Fans "On" Threshold</b>	Cooling Tower Fans "On" Threshold. The value of Cooling Tower Fans Current (or Power) above which the cooling tower fans are considered "on." Used to determine if the cooling tower fans are "on."	Current in amps.
<b>CT Fans "Off" Set Point</b>	The cooling tower "off" set point = the value of the sump temperature below which the cooling tower fans are turned off.	Temperature in degrees F.
<b>CT Fans P</b>	Cooling Tower Fans P. Fraction of Cooling Tower Fan Motors Rated Current (or Power) selected for the "On" Threshold.	Current in amps.
<b>CT Fans Staging OK/Not</b>	Variable indicating whether the fan staging is Ok or not.	"OK (as far as we can tell)." "OK." "Not OK. There is a fan staging problem and the cooling tower is not maintaining the Sump Temp as low as it could/should." "Not OK. There is a fan staging problem and energy is being wasted. All CT Fans should be off."
<b>CT Fans Status</b>	Cooling Tower Fans Status. For water cooled chillers, a variable indicating whether the cooling tower fans are on or off. Takes values of "on" or "off."	On or Off.
<b>CT Fans/Condenser Pumps Interlock OK/Not</b>	An indicator of whether the cooling tower fans and the condenser pumps are properly interlocked or not.	OK or Not OK.



Automated Diagnostics	Version: 1.1
Software Requirements Specification	Date: 8/28/2003
<document identifier>	

Variable	Definition	Values
<b>CT Inlet Temperature</b>	Temperature of the cooling water entering the cooling tower. This temperature will be very close to the temperature of the water leaving the condenser of the chiller.	Temperature in degrees F.
<b>CT Range</b>	Cooling Tower Range = The difference between the temperature of the water entering the cooling tower (cooling tower inlet temperature) and the temperature of the water leaving the cooling tower (outlet temperature).	Temperature difference in degrees F.
<b>CT Range Benchmark</b>	Benchmark for comparison of calculated values of the CT range (may be a user input based on the control spec, specified by the manufacturer or determined by analysis of operating data. TBD)	Degrees F.
<b>CT Range OK/Not</b>	Variable indicating whether the CT range calculated from measurements is equal or greater than the expected range (given by the CT Range Benchmark), in which case it is OK, or whether it is less than expected, in which case it is not OK because the cooling tower is transferring less heat at maximum capacity than expected.	OK or Not OK. There is a problem with CT heat rejection and it is performing at less than expected capacity.
<b>CT Sump Temp Setpoint</b>	The setpoint for the water in the cooling tower sump, i.e., the temperature setpoint for the water leaving the cooling tower.	Temperature in degrees F.
<b>CT Sump Temperature</b>	The temperature of the cooling tower sump, which is the same as the temperature of the water leaving the cooling tower of the cooling tower outlet temperature.	Temperature in degrees F.
<b>Current Time</b>	The time of the current time step	Time in minutes.
<b>Identification of Condition</b>	This data flow represents the collection of all output data from the diagnostic process(es), which characterize the condition of the equipment/systems undergoing diagnosis. This term is only used on the chiller context diagram. All other diagrams show individual data flows.	
<b>Last Chilled Water Pumps Status (Last CHW Pumps Status)</b>	The value of the CHW Pumps Status at the measurement time immediately preceding the current measurement time (i.e., at the last measurement time).	On or Off

Automated Diagnostics	Version: 1.1
Software Requirements Specification	Date: 8/28/2003
<document identifier>	

Variable	Definition	Values
<b>Last Chiller Status</b>	The value of Chiller Status at the measurement time immediately preceding the current measurement time (i.e., the last measurement time). Last Chiller Status = Last Compressor Status.	On or Off
<b>Last CHWST for Compressor "On" Time</b>	Chilled Water Supply Temperature corresponding to the last measurement time when the compressor was on immediately preceding the current measurement time.	Temperature in degrees F.
<b>Last Compressor Off Interval</b>	The length of time the compressor was off the last time it was off. Last Compressor Off Interval = Last Compressor Switch On Time – Last Compressor Switch Off Time. Only evaluated when the compressor is currently on.	Time difference in minutes.
<b>Last Compressor Switch Off Time</b>	The last time at which the Compressor turned off, i.e., the last measurement time at which the Compressor Status changed from "On" to "Off."	Time in minutes.
<b>Last Compressor On Interval</b>	The length of time the compressor was on the last time it was on. Last Compressor On Interval = Last Compressor Off Time – Last Compressor On Time. Only evaluated when the compressor is currently off.	Time difference in minutes.
<b>Last Compressor Switch On Time</b>	The last time at which the Compressor turned on, i.e., the last measurement time at which the Compressor Status changed from "Off" to "On."	Time in minutes.
<b>Last Compressor State</b>	The value of Compressor State at the measurement time immediately preceding the current measurement time (i.e., the last measurement time).	Time in minutes.
<b>Last Compressor Status</b>	The value of Compressor Status at the measurement time immediately preceding the current measurement time (i.e., the last measurement time). Last Compressor Status = Last Chiller Status.	Time in minutes.
<b>Last Condenser Pumps Status</b>	The value of Condenser Pumps Status at the measurement time immediately preceding the current measurement time (i.e., the last measurement time).	Time in minutes.
<b>Last CT Fan Off Interval</b>	The length of time the CT fans were off the last time they were off. Last CT Fan Off Interval = Last CT Fans On Time – Last CT Fans Off Time. Only evaluated when the compressor is currently on.	Time difference in minutes.

Automated Diagnostics	Version: 1.1
Software Requirements Specification	Date: 8/28/2003
<document identifier>	

Variable	Definition	Values
<b>Last CT Fans Off Time</b>	The last time at which the CT Fans turned on, i.e., the last measurement time at which the CT fans status changed from "Off" to "On."	Absolute time in minutes.
<b>Last CT Fans On Time</b>	The last time at which the CT Fans turned off, i.e., the last measurement time at which the CT fans status changed from "On" to "Off."	Absolute time in minutes.
<b>Last CT Fans Status</b>	The value of the CT fans status at the measurement time immediately preceding the current measurement time (i.e., at the last measurement time).	On or Off.
<b>Last Fans On Interval</b>	The length of time the CT fans were on the last time they were on. Last CT Fan On Interval = Last CT Fans Off Time – Last CT Fans on Time. Only evaluated when the compressor is currently off.	Time difference in minutes.
<b>Measurement Time</b>	The time at which measured (or metered) data are collected.	Time in minutes.
<b>Metered Data</b>	The collection of all input data that is collected periodically from sensors or observations. Values of metered data are updated periodically at the measurement frequency. It can be contrasted with set-up data, which is generally collected only once. Metered data is generally used to characterize the condition (or state) of the equipment and systems at a particular point in time. This term is used only on the chiller context diagram. All other diagrams show individual data flows.	
<b>Min. CT Fans Off Time</b>	The minimum permissible time increment that the cooling tower fans should be off before being turned on again in order to prevent damage to the fan motors during fan cycling, as specified by the manufacturer.	Time in minutes.
<b>Min. CT Fans On Time</b>	The minimum permissible time increment that the cooling tower fans should be on before being turned off again in order to prevent damage to the fan motors during fan cycling, as specified by the manufacturer.	Time in minutes.

Automated Diagnostics	Version: 1.1
Software Requirements Specification	Date: 8/28/2003
<document identifier>	

Variable	Definition	Values
<b>Minimum Compressor Off Time</b>	The minimum time specified by the manufacturer (or other authority) that the compressor should be off before being turned back on again.	Time in minutes.
<b>Minimum Compressor On Time</b>	The minimum time specified by the manufacturer (or other authority) that the compressor should be on before being turned back off again.	Time in minutes.
<b>Minimum Transient Decrease in CHWST</b>	The minimum transient decrease in the chilled water supply temperature. This is the minimum change in chilled water supply temperature between two sequential measurement times that would be judged as corresponding to a transient compressor state. All values of the change in CHWST between two successive measurement times would be judged as corresponding to a steady state for the compressor.	Temperature difference in F.
<b>OAT Steady State CHW</b>	Outdoor-Air Temperature while the Chilled Water Temperature is in a steady state, i.e., when Compressor State = Steady.	Temperature in degrees F.
<b>Outdoor-Air Temperature (OAT)</b>	Equivalent to Ambient-Air Temperature (OAT) and is the dry-bulb temperature of the ambient outdoor air.	Temperature in degrees F.
<b>Outdoor-Air Temperature Wet Bulb (OATWB)</b>	Wet-bulb temperature of the outdoor air. Equivalent to Ambient Wet-Bulb Temperature and Outdoor-Air Wet-Bulb Temperature	Temperature in degrees F.
<b>Outdoor-Air Wet-Bulb Temperature (OATWB)</b>	Wet-bulb temperature of the outdoor air. Equivalent to Ambient Wet-Bulb Temperature and Outdoor-Air Temperature Wet Bulb (OATWB)	Temperature in degrees F.
<b>Passed (Filtered) CT Approach</b>	Values of the CT approach for times when the condenser pumps status is "on"	Temperature difference in degrees F
<b>Passed (Filtered) Ambient wb Temp</b>	Values of the Ambient wb temperature for times when the condenser pump status is "on"	Temperature in degrees F.
<b>Passed (Filtered) CT Sump Temp</b>	Values of the sump temperature for times when the condenser pumps are on.	Temperature in degrees F
<b>Passed (Filtered) CT Range</b>	Values of the CT range for times when the condenser pumps status is "on"	Temperature difference in degrees F
<b>Passed (Filtered) CT Fans Current</b>	Values of the Fans Current for times when the condenser pumps are on.	Current in amps

Automated Diagnostics	Version: 1.1
Software Requirements Specification	Date: 8/28/2003
<document identifier>	

Variable	Definition	Values
<b>Passed (Filtered) CT Fans Current</b>	Values of the CT Fans Current occurring when the Condenser Pumps status is "on" (i.e., belong to triplets for which Condenser Pumps Status = On).	Current in amps
<b>Passed (Filtered) CT Fans Status</b>	Values of the CT Fans Status occurring when the Condenser Pumps status is "on" (i.e., belong to triplets for which Condenser Pumps Status = On).	On Off
<b>Passed Ambient wb Temp Points for Condenser Pumps On, CT Fans Status On, and Sump Temp Above the CT Fans "On" Setpoint</b>	Values of the ambient wb temperature for times when the condenser pumps are on, the CT fans status is on, and the sump temperature is above its setpoint	Temperature in degrees F.
<b>Passed CT Range for Condenser Pumps On, CT Fans Status On, and Sump Temp Above the CT Fans "On" Setpoint</b>	Values of the CT Range for times when the condenser pumps are on, the CT fans status is on, and the sump temperature is above its setpoint	Temperature difference in degrees F
<b>Preceding Condenser Pumps Status</b>	The Condenser Pumps Status at the measurement time immediately preceding the measurement time to which reference is made.	On or Off.
<b>Rejected Ambient wb Temp Points for CT Fans Status Off and/or for Sump Temp Below the CT Fans "On" Setpoint</b>	Values of the ambient temperature that correspond to times when the condenser pumps are on and either or both the CT fans status are off or the sump temperature is below or equal to its setpoint.	Temperature in degrees F
<b>Rejected Ambient wb Temp When Condenser Pumps are "Off"</b>	Values of ambient wb temperature that correspond to times when the condenser pumps are off, which are filtered out	Temperature in degrees F
<b>Rejected CHWST for Non-Steady CHWST</b>	Rejected values of CHWST corresponding to times when the Compressor State = "Transient", or Compressor State = "Off", i.e., when the CHWST is not steady.	Temperature in degrees F.
<b>Rejected CT Approach and Ambient wb Temp When Condenser Pumps are "Off"</b>	Values of CT Approach and Ambient wb Temperature that correspond to times when the condenser pumps are off, which are filtered out	

Automated Diagnostics	Version: 1.1
Software Requirements Specification	Date: 8/28/2003
<document identifier>	

Variable	Definition	Values
<b>Rejected CT Approach and Ambient wb Temp Points for CT Fans Status Off and/or for Sump Temp Below the CT Fans "On" Setpoint</b>	Values of the CT Approach and ambient temperature that correspond to times when the CT fans status is "off" and/or the sump temperature is below the CT Fans "On" set point.	
<b>Rejected CT Fans Current When Condenser Pumps are "Off"</b>	Values of the CT Fans Current for times when the condenser pumps are off.	Current in amps
<b>Rejected CT Range for CT Fans Status Off and/or Sump Temp Below the CT Fans "On" Setpoint</b>	Values of the CT Range that correspond to times when the condenser pumps are on and either or both the CT fans status is off or the sump temperature is below or equal to its setpoint.	Temperature difference in degrees F
<b>Rejected CT Range When Condenser Pumps are "Off"</b>	Values of CT Range that correspond to times when the condenser pumps are off, which are filtered out	Temperature difference in degrees F
<b>Rejected CT Sump Temp When Condenser Pumps are "Off"</b>	Values of the Sump Temperature at times when the condenser pumps are off	Temperature in degrees F
<b>Rejected OAT for Non-Steady CHWST</b>	Rejected values of OAT corresponding to times when the Compressor State = "Transient" or Compressor State = "Off", i.e., when the CHWST is not steady.	Temperature in degrees F.
<b>Secondary CHW Pumps Collective Status</b>	The status of all the secondary chilled water pumps in an associated set taken as a single unit. If at least one pump of the set is ON, the collective status is ON. If all the pumps in the set are OFF, the collective status is OFF.	On or Off.
<b>Secondary CHW Pumps Motor Rated Current (or Power)</b>	Secondary Chilled Water Pumps Motor Rated Current (or Power). Current (or power) rating of the secondary CHW pump motor from the motors nameplate(s).	Current in amps.

Automated Diagnostics	Version: 1.1
Software Requirements Specification	Date: 8/28/2003
<document identifier>	

Variable	Definition	Values
<b>Secondary CHW Pumps "On" Threshold</b>	The value of Secondary CHW Pumps Current (or Power) above which the secondary CHW Pumps is considered "on." Used to determine if the secondary chilled water Pumps is (are) "on."	Current in amps.
<b>Secondary CHW Pumps P</b>	Secondary Chilled Water Pumps P. Fraction of Secondary Chilled Water Pumps Motors Rated Current (or Power) selected for the "On" Threshold.	Dimensionless real number between 0.0 and 1.0.
<b>Secondary CHW Pumps Current (or Power)</b>	The measured value of current (or power) for the secondary CHW Pumps at the current time.	Current in amps.
<b>Secondary/Primary CHW Pumps Interlock OK/not</b>	For chilled water distribution systems with secondary CHW pumps. An indicator of whether the primary CHW pumps and the secondary CHW pumps served by it are properly interlocked or not. It takes values of "OK" and "Not OK."	Ok. Not Ok.
<b>Set-up Data</b>	The collection of all input data that characterizes the equipment and systems in place in the building as well as its performance. It is generally entered only once for a specific building or specific piece of equipment and can be contrasted with metered data which is collected periodically. This term is used only on the chiller context diagram. All other diagrams show individual data flows.	
<b>Sump Temp Control OK/Not</b>	A variable indicating whether the sump temperature control is OK or not at the current time	OK Not OK. The CT fans are off but should be on. Not OK. The CT fans are on but should be off.
<b>Supply Fan Motors Rated Current (or Power)</b>	Current (or power) rating of the supply fan motors from the motor nameplates.	Current in amps.
<b>Supply Fans Status</b>	An indicator of whether the supply fans are on or off. Takes values of "on" or "off."	On or off
<b>Supply Fans "On" Threshold</b>	The value of Supply Fans Current (or Power) above which the supply fans are considered "on." Used to determine if the supply fans are "on."	Current in amps.

Automated Diagnostics	Version: 1.1
Software Requirements Specification	Date: 8/28/2003
<document identifier>	

Variable	Definition	Values
<b>Supply Fans Current (or Power)</b>	The measured value of current (or power) for the supply fans.	Current in amps.
<b>Supply Fans P</b>	Fraction of Supply Fan Motors Rated Current (or Power) selected for the "On" Threshold.	Dimensionless real number between 0.0 and 1.0.
<b>Supply Fans/Secondary CHW Pumps Interlock OK/not</b>	For chilled water distribution systems with secondary pumps. An indicator of whether the secondary CHW pumps and the supply fans for the air handlers served by them are properly interlocked or not. It takes values of "OK," "Not OK," and "Possible problem with supply fan control--check to see if loads in the spaces served are being met."	Ok. Not Ok. Not OK," and "Possible problem with supply fan control--check to see if loads in the spaces served are being met."
<b>Supply Fans/CHW Pumps Interlock OK/not</b>	An indicator of whether the primary CHW pumps and the supply fans for the air handlers served by them are properly interlocked or not. It takes values of "OK," "Not OK," and "Possible problem with supply fan control--check to see if loads in the spaces served are being met"	Ok. Not Ok. Possible problem with supply fan control--check to see if loads in the spaces served are being met.
<b>Total Number of Time Steps Processed</b>	The total number of time steps for which processing has been performed since processing was started and up to the current time. It takes integer values.	Integer.
<b>Water side Economizing</b>	Variable that indicates whether water side economizing is used or not.	Yes No



Automated Diagnostics	Version: 1.1
Software Requirements Specification	Date: 8/28/2003
<document identifier>	

## 6. Appendix C: Data Flow Diagrams for Boiler Diagnostic Processes

Automated Diagnostics	Version: 1.1
Software Requirements Specification	Date: 8/28/2003
<document identifier>	

## Context Diagram Boiler

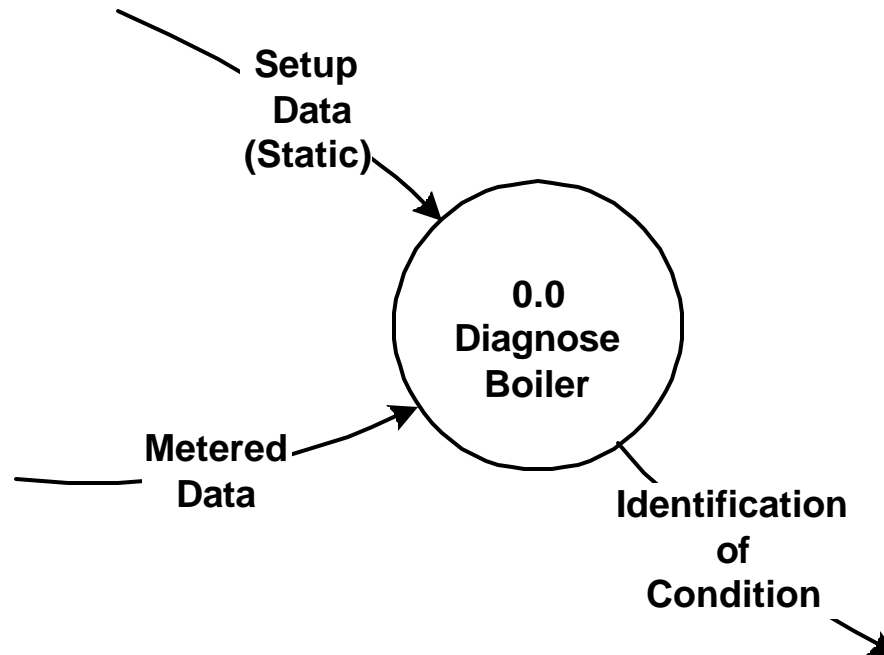

Automated Diagnostics	Version: 1.1
Software Requirements Specification	Date: 8/28/2003
<document identifier>	

## 0.0 Diagnose Boiler

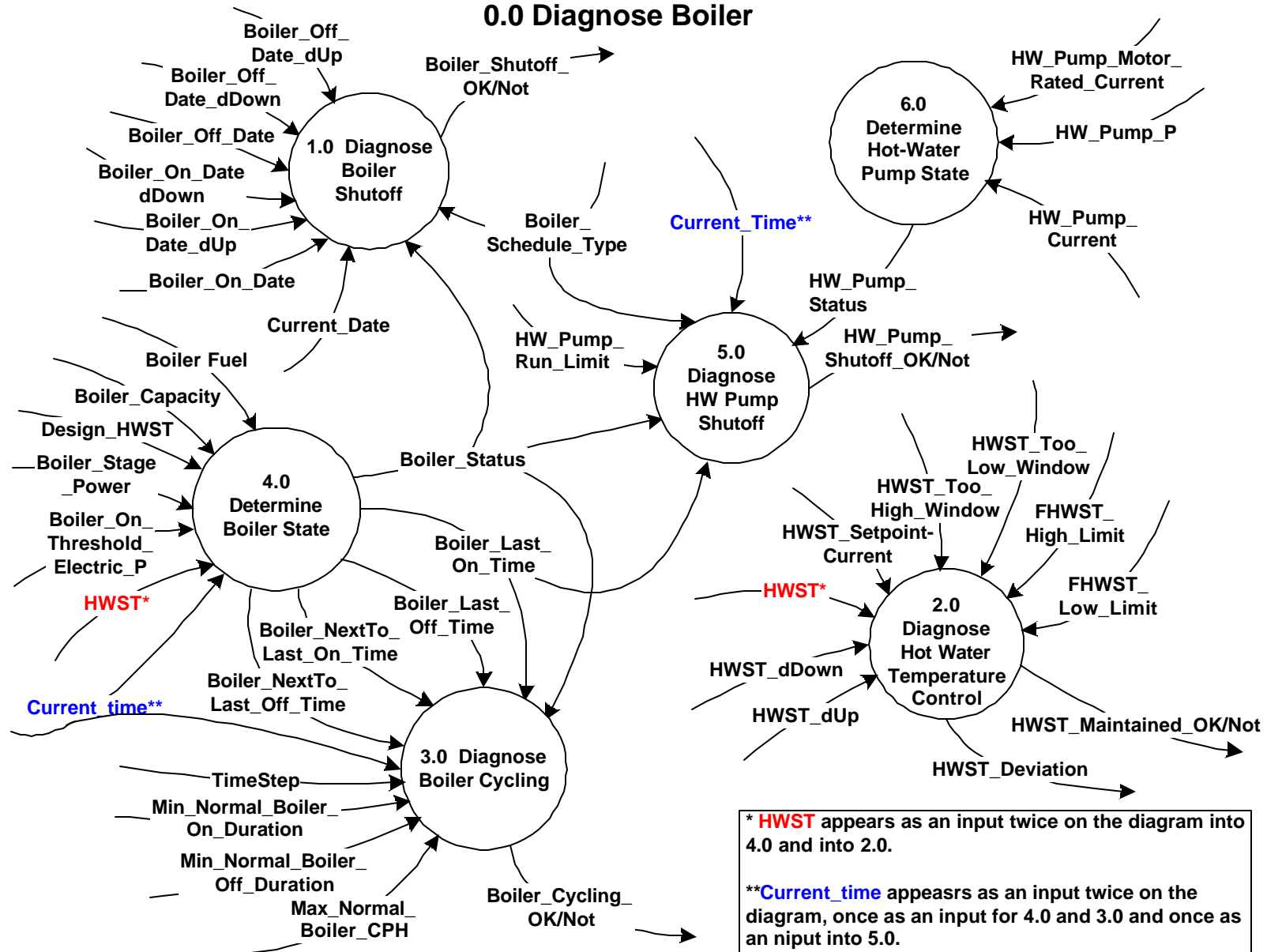

Automated Diagnostics	Version: 1.1
Software Requirements Specification	Date: 8/28/2003
<document identifier>	

## 1.0 Diagnose Boiler Shutoff

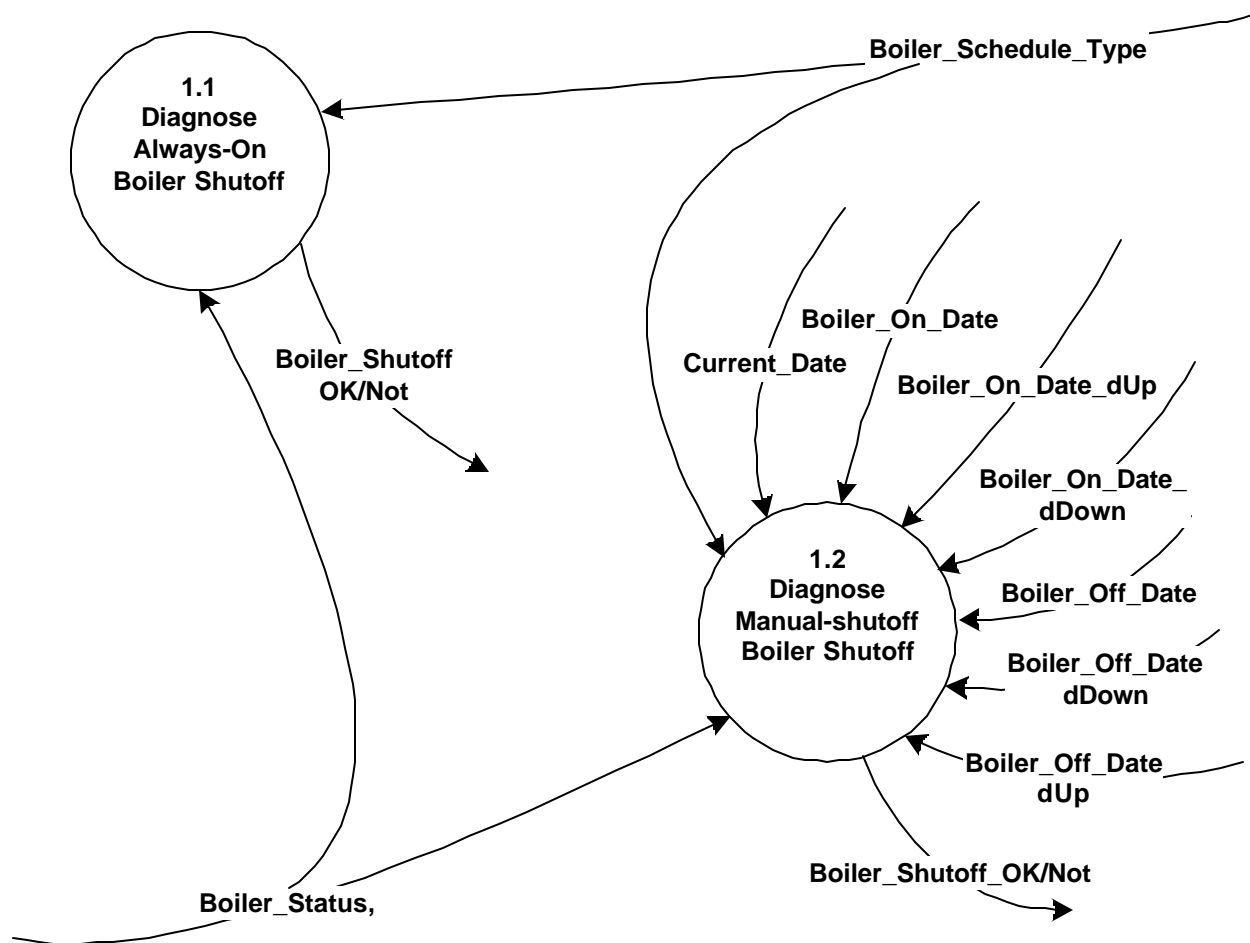

*Note: No diagnosis is provided for Ambient-Temperature-Based or other temperature-based boiler shutoffs. Further development is required for these diagnostic procedures.*

Automated Diagnostics	Version: 1.1
Software Requirements Specification	Date: 8/28/2003
<document identifier>	

## 1.1 Diagnose Always-On-Boiler Shutoff

If Boiler\_Schedule\_Type = "Always On" AND Boiler\_Status = "On"

Set Boiler\_Shutoff\_OK/Not = "OK. The boiler is on as it should be. Shutoff is not applicable to this boiler. The boiler system is designed for continuous operation."

If Boiler\_Schedule\_Type = "Always On" AND Boiler\_Status = "Off"

Set Boiler\_Shutoff\_OK/Not = "Not OK; the boiler is off and it should be on always, unless it is locked out temporarily for maintenance or repair."

Automated Diagnostics	Version: 1.1
Software Requirements Specification	Date: 8/28/2003
<document identifier>	

## 1.2 Diagnose Manual-shutoff-Boiler Shutoff

If Boiler\_Schedule\_Type = "Manual Shutoff" AND Boiler\_Status = "On"  
 AND if Current\_Date > Boiler\_On\_Date + Boiler\_On\_Date\_dUp  
 Set Boiler\_Shutoff\_OK/Not = "OK; the boiler is on as it should be."

If Boiler\_Schedule\_Type = "Manual Shutoff" AND Boiler\_Status = "Off"  
 AND if Current\_Date > Boiler\_On\_Date + Boiler\_On\_Date\_dUp  
 Set Boiler\_Shutoff\_OK/Not = "Not OK; the boiler is off when it should be on."

If Boiler\_Schedule\_Type = "Manual Shutoff" AND Boiler\_Status = "On"  
 AND if Current\_Date < Boiler\_Off\_Date - Boiler\_Off\_Date\_dDown,  
 Set Boiler\_Shutoff\_OK/Not = "OK; the boiler is on as it should be."

If Boiler\_Schedule\_Type = "Manual Shutoff" AND Boiler\_Status = "Off"  
 AND if Current\_Date < Boiler\_Off\_Date - Boiler\_Off\_Date\_dDown,  
 Set Boiler\_Shutoff\_OK/Not = "Not OK; the boiler is off when it should be on."

If Boiler\_Schedule\_Type = "Manual Shutoff" AND Boiler\_Status = "Off"  
 AND If Current\_Date < Boiler\_On\_Date - Boiler\_On\_Date\_dDown,  
 AND If Current\_Date > Boiler\_Off\_Date + Boiler\_Off\_Date\_dUp,  
 Set Boiler\_Shutoff\_OK/Not = "OK; the boiler is off as it should be"

If Boiler\_Schedule\_Type = "Manual Shutoff"  
 AND If Current\_Date > Boiler\_On\_Date - Boiler\_On\_Date\_dDown,  
 AND If Current\_Date < Boiler\_On\_Date + Boiler\_On\_Date\_dUp,  
 Set Boiler\_Shutoff\_OK/Not = "Ok; the date is too close to the Boiler On Date to evaluate compliance with the schedule."

If Boiler\_Schedule\_Type = "Manual Shutoff"  
 AND If Current\_Date > Boiler\_Off\_Date - Boiler\_Off\_Date\_dDown,  
 AND If Current\_Date < Boiler\_Off\_Date + Boiler\_Off\_Date\_dUp,  
 Set Boiler\_Shutoff\_OK/Not = "Ok; the date is too close to the Boiler Off Date to evaluate compliance with the schedule."

Automated Diagnostics	Version: 1.1
Software Requirements Specification	Date: 8/28/2003
<document identifier>	

## 2.0 Diagnose Hot Water Temperature Control

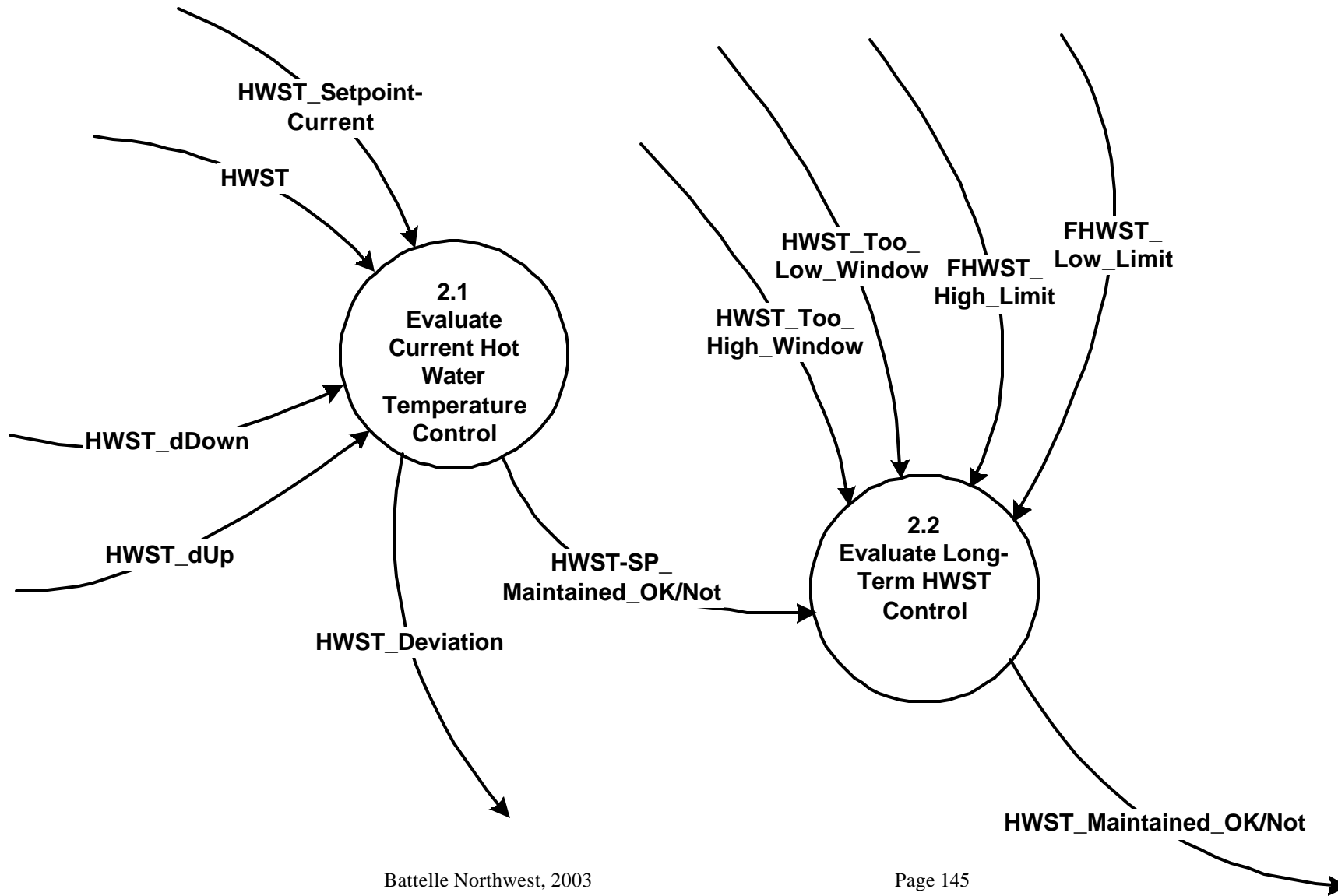

Automated Diagnostics	Version: 1.1
Software Requirements Specification	Date: 8/28/2003
<document identifier>	

## 2.1 Evaluate Current Hot Water Temperature

Calculate the upper bound for acceptable Hot Water Supply Temperature using

$$\text{HWST Upper Bound} = \text{HWST\_Setpoint-Current} + \text{HWST\_dUp}$$

Calculate the lower bound for acceptable Hot Water Supply Temperature using

$$\text{HWST Lower Bound} = \text{HWST\_Setpoint-Current} - \text{HWST\_dDown}$$

Compare the Hot Water Supply Temperature (HWST) to the HWST Upper Bound and HWST Lower Bound.

If  $\text{HWST} > \text{HWST Upper Bound}$ , then  
Set  $\text{HWST-SP\_Maintained\_OK/Not} = \text{"Too high"}$  for the current time.

If  $\text{HWST} < \text{HWST Lower Bound}$ , then  
Set  $\text{HWST-SP\_Maintained\_OK/Not} = \text{"Too low"}$  for the current time.

If  $\text{HWST} \leq \text{HWST Upper Bound}$ , AND  
 $\text{HWST} \geq \text{HWST Lower Bound}$ , then  
Set  $\text{HWST\_Maintained\_OK/Not} = \text{"OK"}$  for the current time.

Calculate the HWST Deviation for the current time

$$\text{HWST\_Deviation} = \text{HWST} - \text{HWST\_Setpoint-Current}.$$



Automated Diagnostics	Version: 1.1
Software Requirements Specification	Date: 8/28/2003
<document identifier>	

## 2.2 Evaluate Long-Term HWST Control

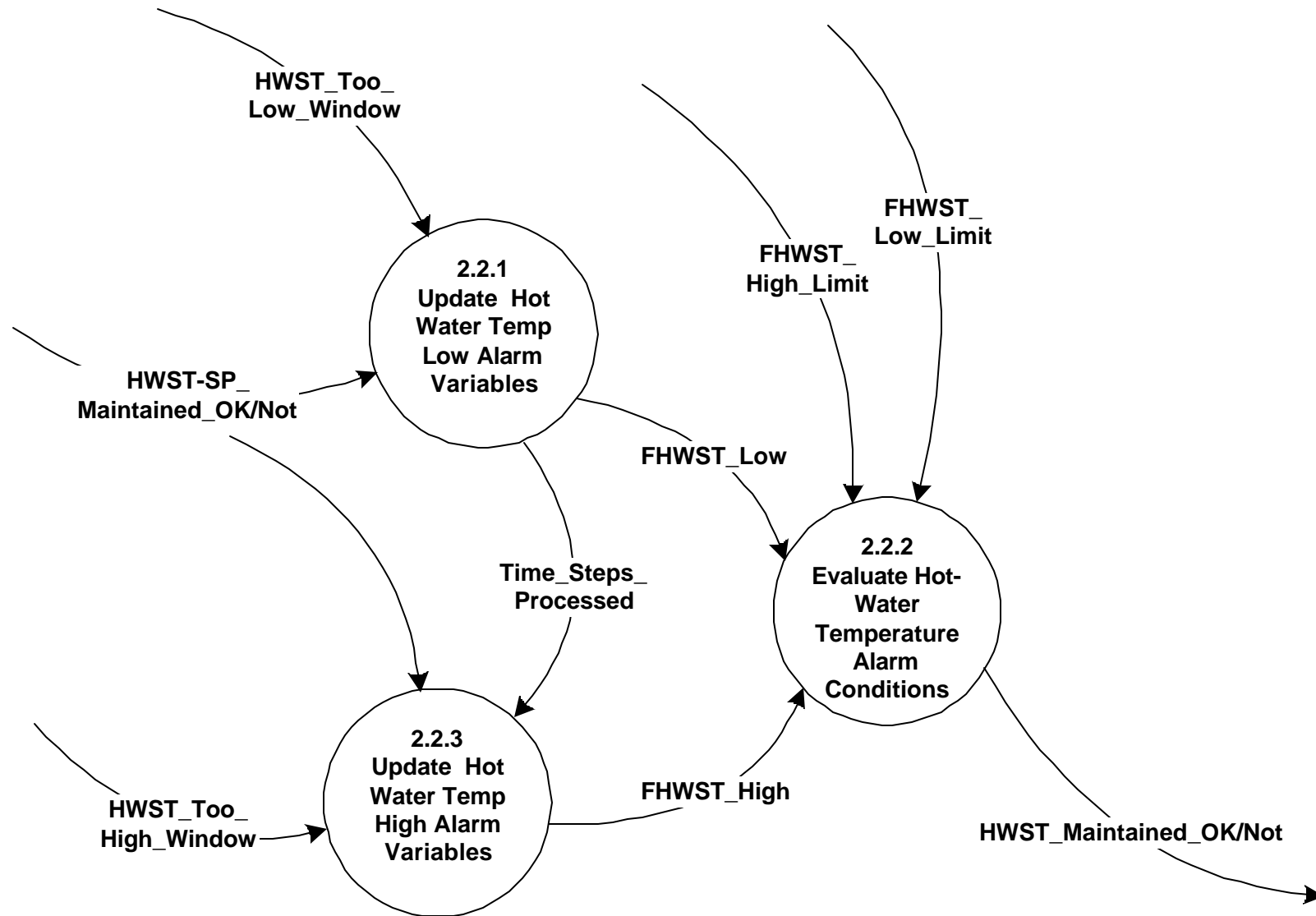

Automated Diagnostics	Version: 1.1
Software Requirements Specification	Date: 8/28/2003
<document identifier>	

## 2.2.1 Update Hot Water Temp Low Alarm Variables

Update the Time\_Steps\_Processed, using

$$\text{Time\_Steps\_Processed} = \text{Time\_Steps\_Processed} + 1$$

Update the value of FHWST\_Low based on the latest value of HWST\_Maintained\_OK/Not.

Update the HWST\_Maintained\_OK/not\_Too-Low\_Array

Update all values in the array, adding the current value of HWST\_Maintained\_OK/not to the array and by dropping the oldest value of HWST\_Maintained\_OK/not from the array.

Update value for HWSTNumber\_Low.

Set HWSTNumber\_Low = number of values "Too Low" appearing in HWST\_Maintained OK/Not\_Too-Low\_Array.

If Total\_Number\_of\_Time\_Steps\_Processed < HWST\_Too\_Low\_Window, then set HWSTNumber\_Low = 0.

Calculate the new value of FHWST\_Low.

$$\text{FHWST\_Low} = \text{HWSTNumber\_Low}/(\text{HWST\_Too\_Low\_Window})$$

Automated Diagnostics	Version: 1.1
Software Requirements Specification	Date: 8/28/2003
<document identifier>	

## 2.2.2 Evaluate Hot-Water Temperature Alarm Conditions

Check if the long-term average hot-water supply temperature (HWST) is adequately maintained or whether it is high or low by comparing FHWST\_High and FHWST\_Low with their respective limits.

If FHWST\_High  $\geq$  FHWST\_High\_Limit,  
Set HWST\_Maintained\_OK/Not = "Too high"

If FHWST\_Low  $\geq$  FHWST\_Low\_Limit,  
Set HWST\_Maintained\_OK/Not = "Too low"

If FHWST\_High < FHWST\_High\_Limit, AND  
FHWST\_Low < FHWST\_Low\_Limit,  
Set HWST\_Maintained\_OK/Not = "OK"

Automated Diagnostics	Version: 1.1
Software Requirements Specification	Date: 8/28/2003
<document identifier>	

## 2.2.3 Update Hot Water Temp High Alarm Variables

Update the value of FHWST\_High based on the latest value of HWST\_Maintained\_OK/Not.

Update the HWST\_Maintained\_OK/not\_Too-High\_Array

Update all values in the array, adding the current value of HWST\_Maintained\_OK/not to the array and by dropping the oldest value of HWST\_Maintained\_OK/not from the array.

Update value for HWSTNumber\_High.

Set HWSTNumber\_High = number of values "Too High" appearing in HWST\_Maintained\_OK/not\_Too-High\_Array.

If Total Number of Time Steps Processed < HWST\_Too\_High\_Window, then set HWSTNumber\_High = 0.

Calculate the new value of FHWST\_High.

$$\text{FHWST\_High} = \text{HWSTNumber\_High} / (\text{HWST\_Too\_High\_Window})$$

Automated Diagnostics	Version: 1.1
Software Requirements Specification	Date: 8/28/2003
<document identifier>	

### 3.0 Diagnose Boiler Cycling

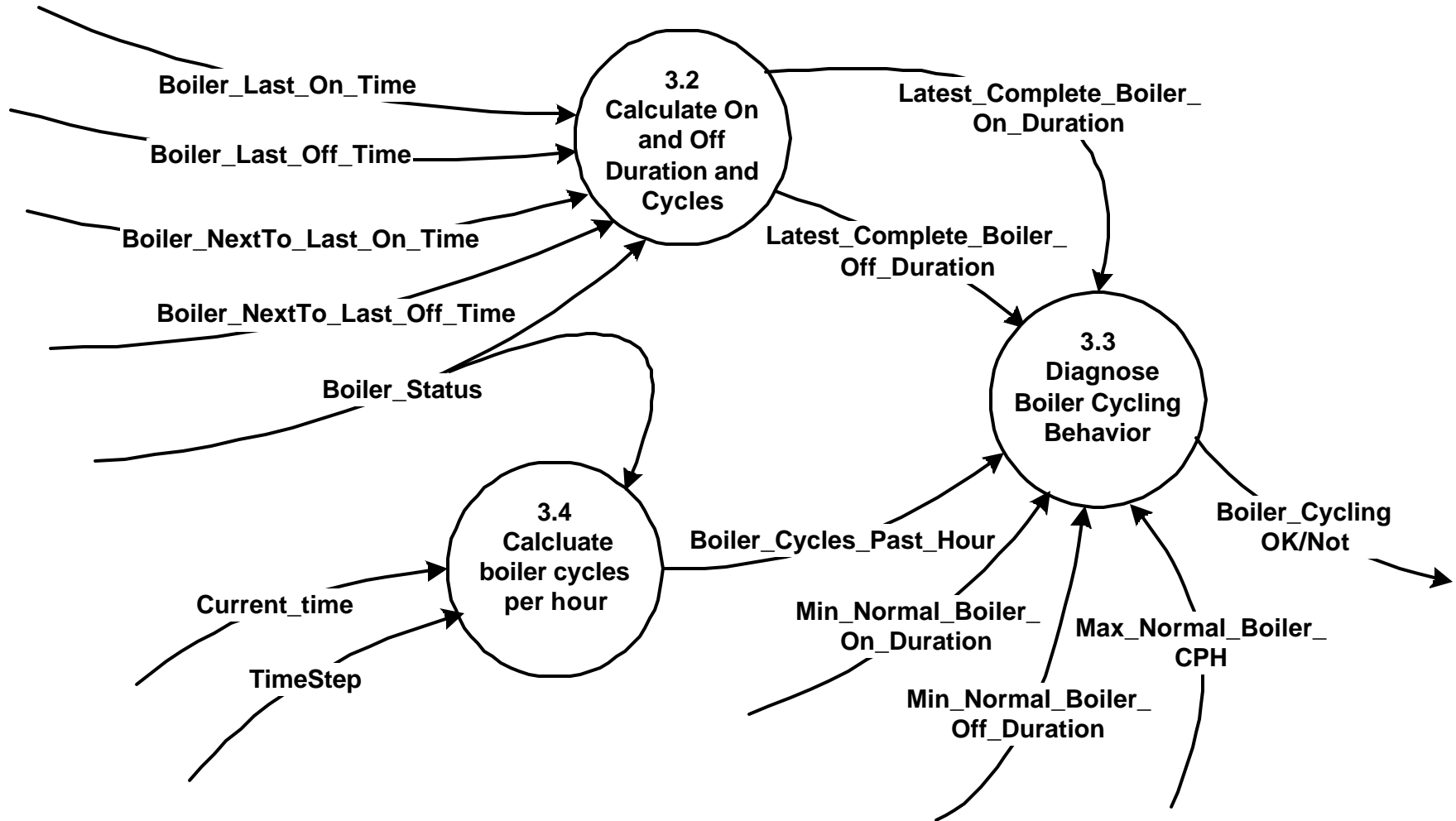

Automated Diagnostics	Version: 1.1
Software Requirements Specification	Date: 8/28/2003
<document identifier>	

## 3.2 Calculate On and Off Duration and Cycles

Calculate Latest\_Complete\_Boiler\_On\_Duration

If Boiler\_Status = "On"

Set Latest\_Complete\_Boiler\_On\_Duration = Boiler\_Last\_Off\_Time - Boiler\_NextTo\_Last\_On\_Time

If Boiler\_Status = "Off"

Set Latest\_Complete\_Boiler\_On\_Duration = Boiler\_Last\_Off\_Time - Boiler\_Last\_On\_Time

Calculate Latest\_Complete\_Boiler\_Off\_Duration

If Boiler\_Status = "Off"

Set Latest\_Complete\_Boiler\_Off\_Duration = Boiler\_Last\_On\_Time - Boiler\_NextTo\_Last\_Off\_Time

If Boiler\_Status = "On"

Set Latest\_Complete\_Boiler\_Off\_Duration = Boiler\_Last\_On\_Time - Boiler\_Last\_Off\_Time

Automated Diagnostics	Version: 1.1
Software Requirements Specification	Date: 8/28/2003
<document identifier>	

### 3.3 Diagnose Boiler Cycling Behavior

If Boiler\_Cycles\_Past\_Hour > Max\_Normal\_Boiler\_CPH, AND  
Latest\_Complete\_Boiler\_On\_Duration < Min\_Normal\_Boiler\_On\_Duration AND  
Latest\_Complete\_Boiler\_Off\_Duration < Min\_Normal\_Boiler\_Off\_Duration,  
then set Boiler\_Cycling\_OK/Not = "Not OK. The Boiler is cycling on and off  
excessively."

If Boiler\_Cycles\_Past\_Hour > Max\_Normal\_Boiler\_CPH, AND  
Latest\_Complete\_Boiler\_On\_Duration < Min\_Normal\_Boiler\_On\_Duration, AND  
Latest\_Complete\_Boiler\_Off\_Duration >= Min\_Normal\_Boiler\_Off\_Duration,  
then set Boiler\_Cycling\_OK/Not = "Not OK. The Boiler is cycling on excessively."

If Boiler Cycles Past Hour > Max\_Normal\_Boiler\_CPH AND  
Latest\_Complete\_Boiler\_On\_Duration >= Min\_Normal\_Boiler\_On\_Duration, AND  
Latest\_Complete\_Boiler\_Off\_Duration < Min\_Normal\_Boiler\_Off\_Duration,  
then set Boiler\_Cycling\_OK/Not = "Not OK. The Boiler is cycling off excessively."

If Boiler Cycles Past Hour <= Max\_Normal\_Boiler\_CPH,  
then set Boiler\_Cycling\_OK/Not = "OK."

Automated Diagnostics	Version: 1.1
Software Requirements Specification	Date: 8/28/2003
<document identifier>	

### 3.4 Calculate boiler cycles per hour

Set number of time steps in an hours

Set  $N_{max} = 60/TimeStep$

Update Boiler\_Status\_Array

$Boiler\_Status(Current\_time - N_{max} * TimeStep) = Boiler\_Status[Current\_time - (N_{max} - 1) * TimeStep]$

$Boiler\_Status[Current\_time - (N_{max} - 1) * TimeStep] = Boiler\_Status[Current\_time - (N_{max} - 2) * TimeStep]$

- 
- 
- 

$Boiler\_Status(Current\_time - 2 * TimeStep) = Boiler\_Status(Current\_time - TimeStep)$

$Boiler\_Status(Current\_time - TimeStep) = Boiler\_Last\_Status$

$Boiler\_Status(Current\_time) = Boiler\_Status$

Calculate Boiler\_Cycles\_Past\_Hour.

Assign BSNumber(nt) for all values of nt from -Nmax to 0,

If Boiler\_Status = "On," set BSNumber(nt) = 1.

If Boiler\_Status = "Off," set BSNumber(nt) = 0.

Set Cycle\_Counts = 0

Evaluate the following for each value of nt for  $-N_{max} \leq nt \leq 0$

(zero corresponding to the current time and -Nmax corresponding to Nmax time steps ago)

If  $Boiler\_Status(Current\_time) = "Off"$  AND  $BSNumber(nt+1) - BSNumber(nt) < 0$

Set  $Cycle\_Counts = Cycle\_Counts + 1$

If  $Boiler\_Status(Current\_time) = "Off"$  AND  $BSNumber(nt+1) - BSNumber(nt) \geq 0$

Set  $Cycle\_Counts = Cycle\_Counts$

If  $Boiler\_Status(Current\_time) = "On"$  AND  $BSNumber(nt+1) - BSNumber(nt) > 0$

Set  $Cycle\_Counts = Cycle\_Counts + 1$

If  $Boiler\_Status(Current\_time) = "On"$  AND  $BSNumber(nt+1) - BSNumber(nt) \leq 0$

Set  $Cycle\_Counts = Cycle\_Counts$

If  $nt < 0$ , repeat for next value of nt.

If  $nt = 0$ , Set  $Boiler\_Cycles\_Past\_Hour = Cycle\_Counts - 1$

*Note: We can probably specify more efficient ways to update the variables used in this cycle counting procedure.*



Automated Diagnostics	Version: 1.1
Software Requirements Specification	Date: 8/28/2003
<document identifier>	

## 4.0 Determine Boiler State

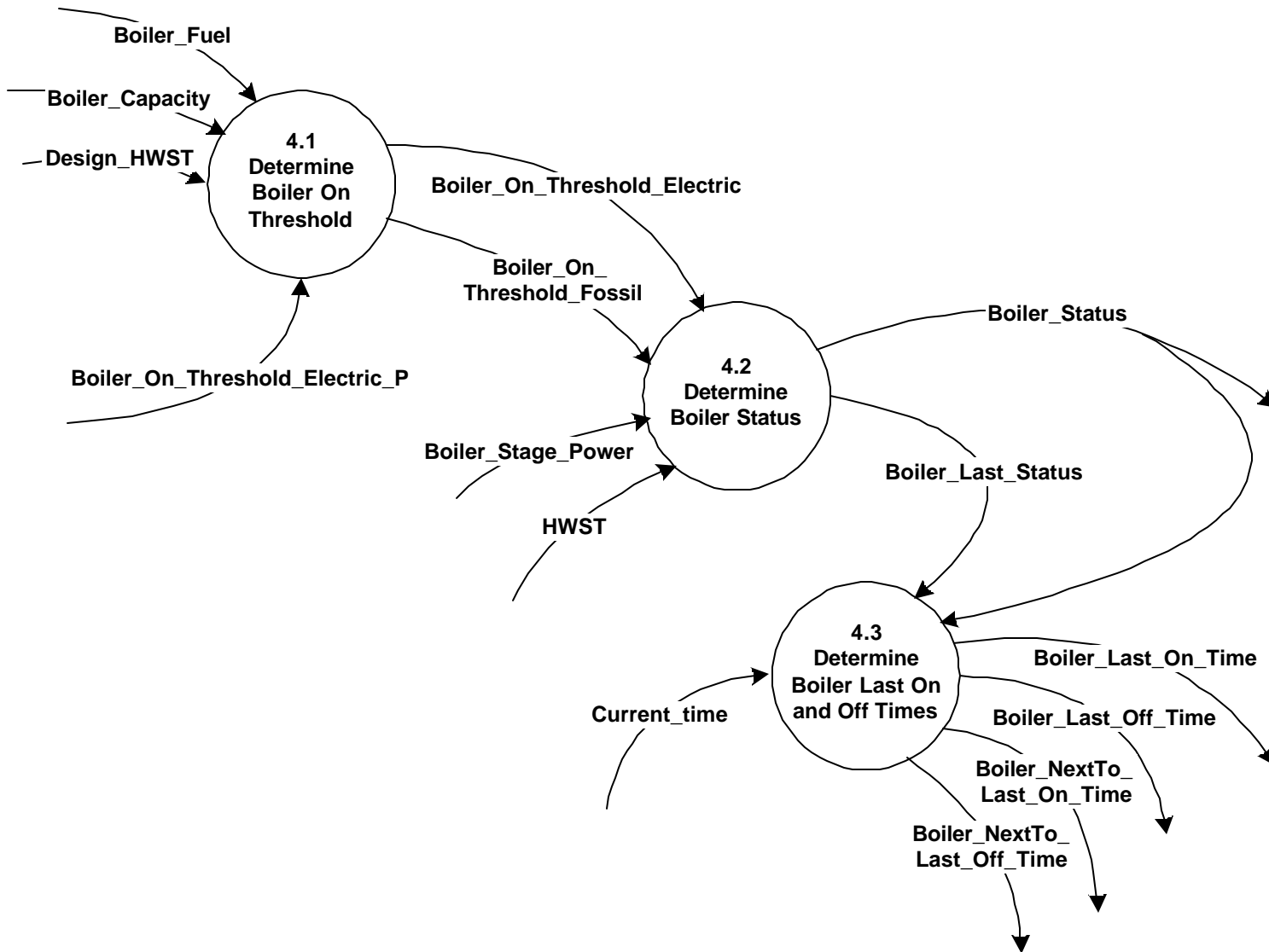

Automated Diagnostics	Version: 1.1
Software Requirements Specification	Date: 8/28/2003
<document identifier>	

## 4.1 Determine Boiler On Threshold

Determine the Boiler Type and set corresponding Boiler "On" threshold.

If Boiler\_Fuel = Electric, then

Set Boiler\_On\_Threshold\_Electric = Boiler\_On\_Threshold\_Electric\_P \*  
Boiler\_Capacity, and  
Set Boiler\_On\_Threshold\_Fossil = null

If the Boiler\_Fuel = Fossil, then

Set Boiler\_On\_Threshold\_Fossil = (Design\_HWST + 75 )/2, and  
Set Boiler\_On\_Threshold\_Electric = null

Automated Diagnostics	Version: 1.1
Software Requirements Specification	Date: 8/28/2003
<document identifier>	

## 4.2 Determine Boiler Status

Update Boiler\_Last\_Status,

Boiler\_Last\_Status = Boiler\_Status

Check if the boiler on thresholds are exceeded. and set the boiler status accordingly.

If Boiler\_Stage\_Power > Boiler On Threshold Electric, then  
set Boiler\_Status = "On"

If HWST > Boiler On Threshold Fossil, then  
set Boiler\_Status = "On"

Otherwise,

If Boiler\_Stage\_Power <= Boiler On Threshold Electric,  
Set Boiler\_Status = "Off"

If HWST <= Boiler On Threshold Fossil,  
Set Boiler\_Status = "Off"

Automated Diagnostics	Version: 1.1
Software Requirements Specification	Date: 8/28/2003
<document identifier>	

### 4.3 Determine Boiler Last On and Off Times

#### Calculate Boiler\_Last\_On\_Time

If Boiler\_Status = "On" and "Boiler\_Last\_Status = "Off," then  
Set Boiler\_NextTo\_Last\_On\_Time = Boiler\_Last\_On\_Time  
Set Boiler\_Last\_On\_Time = Current\_Time

If Boiler\_Status = "On" and "Boiler\_Last\_Status = "On," then  
Set Boiler\_Last\_On\_Time = Boiler\_Last\_On\_Time  
[Note: No change in value of Boiler\_Last\_On\_Time.]

If Boiler\_Status = "Off" and "Boiler\_Last\_Status = "Off," then  
Set Boiler\_Last\_On\_Time = Boiler\_Last\_On\_Time  
[Note: No change in value of Boiler\_Last\_On\_Time.]

If Boiler\_Status = "Off" and "Boiler\_Last\_Status = "On," then  
Set Boiler\_Last\_On\_Time = Boiler\_Last\_On\_Time  
[Note: No change in value of Boiler\_Last\_On\_Time.]

#### Calculate Boiler\_Last\_Off\_Time

If Boiler\_Status = "Off" and "Boiler\_Last\_Status = "On," then  
Set Boiler\_NextTo\_Last\_Off\_Time = Boiler\_Last\_Off\_Time  
Set Boiler\_Last\_Off\_Time = Current\_Time

If Boiler\_Status = "Off" and "Boiler\_Last\_Status = "Off," then  
Set Boiler\_Last\_Off\_Time = Boiler\_Last\_Off\_Time  
[Note: No change in value of Boiler\_Last\_Off\_Time.]

If Boiler\_Status = "On" and "Boiler\_Last\_Status = "On," then  
Set Boiler\_Last\_Off\_Time = Boiler\_Last\_Off\_Time  
[Note: No change in value of Boiler\_Last\_Off\_Time.]

If Boiler\_Status = "On" and "Boiler\_Last\_Status = "Off," then  
Set Boiler\_Last\_Off\_Time = Boiler\_Last\_Off\_Time  
[Note: No change in value of Boiler\_Last\_Off\_Time.]

Automated Diagnostics	Version: 1.1
Software Requirements Specification	Date: 8/28/2003
<document identifier>	

## 5.0 Diagnose HW Pump Shutoff

If Boiler\_Status = "Off" AND HW\_Pump\_Status = "Off"

Set HW\_Pump\_Shutoff\_OK/Not = "OK; the hot-water pump is off as it should be."

If Boiler\_Status = "On" AND HW\_Pump\_Status = "On"

Set HW\_Pump\_Shutoff\_OK/Not = "OK; the hot-water pump is on while the boiler is on."

If Boiler\_Schedule\_Type = "Ambient Shutoff" OR "Manual Shutoff" AND

Boiler\_Status = "Off" AND

HW\_Pump\_Status = "On" AND

Current\_time - Boiler\_Last\_On\_Time <= HW\_Pump\_Run\_Limit, then

Set HW\_Pump\_Shutoff\_OK/Not = "OK; the hot-water pump is running while the boiler is off, but the hot-water run limit has not been exceeded yet."

If Boiler\_Schedule\_Type = "Ambient Shutoff" OR "Manual Shutoff" AND

Boiler\_Status = "Off" AND

HW\_Pump\_Status = "On," AND

Current\_time - Boiler\_Last\_On\_Time > HW\_Pump\_Run\_Limit, then

Set HW\_Pump\_Shutoff\_OK/Not = "Not OK; the hot-water pump is running unnecessarily, wasting energy, and unnecessarily reducing its remaining operating life."

*Note: No diagnostics are provided for HW Pump off while boiler is on. This requires further development. This situation can also present a safety problem so it is important from a safety standpoint as well as efficient operation. Additional diagnostics are needed.*

Automated Diagnostics	Version: 1.1
Software Requirements Specification	Date: 8/28/2003
<document identifier>	

## 6.0 Determine Hot-Water Pump State

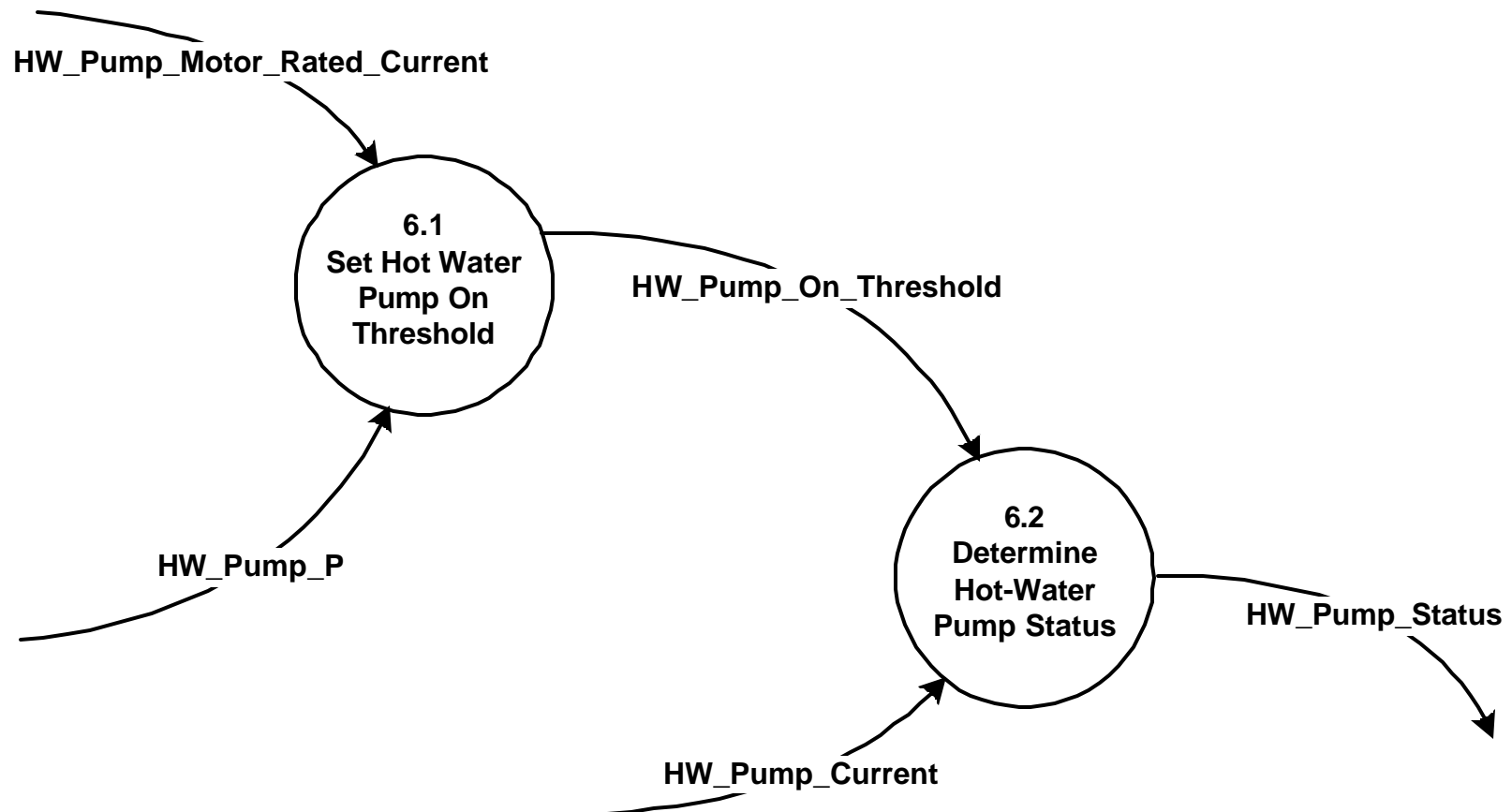

Automated Diagnostics	Version: 1.1
Software Requirements Specification	Date: 8/28/2003
<document identifier>	

## 6.1 Set Hot Water Pump On Threshold

Calculate the HW\_Pump\_On\_Threshold using

$$\text{HW\_Pump\_On\_Threshold} = \text{HW\_Pump\_P} \times \text{HW\_Pump\_Motor\_Rated\_Current}$$

Notes: The value of HW\_Pump\_P can be a user input or a default value.

Automated Diagnostics	Version: 1.1
Software Requirements Specification	Date: 8/28/2003
<document identifier>	

## 6.2 Determine Hot-Water Pump Status

Update HW\_Pump\_Last\_Status

Set HW\_Pump\_Last\_Status = HW\_Pump\_Status

For each value of HW\_Pump\_Current, check if the HW\_Pump\_On\_Threshold is exceeded, and set the hot-water pump status accordingly.

If the value of HW\_Pump\_Current  $\leq$  HW\_Pump\_On\_Threshold, then  
set HW\_Pump\_Status = "Off"

If the value of HW\_Pump\_Current  $>$  HW\_Pump\_On\_Threshold, then  
set HW\_Pump\_Status = "On."



Automated Diagnostics	Version: 1.1
Software Requirements Specification	Date: 8/28/2003
<document identifier>	

## 7. Appendix D: Data Dictionary for Boilers

Automated Diagnostics	Version: 1.1
Software Requirements Specification	Date: 8/28/2003
<document identifier>	

Variable	Definition	Values
<b>Boiler_Capacity</b>	The cumulative rated capacity of all boilers used for space conditioning in Btu/h.	Capacity in Btu/h
<b>Boiler_Cycles_Past_Hour</b>	A variable that indicates the number of complete boiler on/off cycles that have occurred during the hour immediately preceding the current time.	Positive integer.
<b>Boiler_Cycling_OK/Not</b>	Boiler cycling status variable, which can take on values as indicated in the process description.	Ok. "Not OK. The Boiler is cycling on and off excessively." "Not OK. The Boiler is cycling on excessively." "Not OK. The Boiler is cycling off excessively."
<b>Boiler_Fuel</b>	A setup variable that indicates the type of energy source used to fire the boiler.	Electric or Fossil.
<b>Boiler_Last_Off_Time</b>	A variable identifying the absolute time at which the boiler was last shut "Off" (i.e., changed from on to off).	Time in minutes.
<b>Boiler_Last_On_Time</b>	A variable identifying the absolute time at which the boiler was last turned "On" (i.e., changed from off to on).	Time in minutes.
<b>Boiler_Last_Status</b>	The value of the Boiler_Status one time step ago (i.e., the processing time before the current time).	"On" or "Off"
<b>Boiler_NextTo_Last_Off_Time</b>	A variable identifying the absolute at which the boiler was shut "Off" two times ago (i.e., changed from on to off).	Time in minutes.
<b>Boiler_NextTo_Last_On_Time</b>	A variable identifying the absolute time at which the boiler was turned "On" two times ago (i.e., changed from off to on).	Time in minutes.
<b>Boiler_Off_Date</b>	Numeric value for the day of the year on which the boiler is ordinarily turned off at the end of the heating season with the days of the year numbered consecutively; e.g., April 1 is day 91 for a non-leap year.	Numerical value for day of year.

Automated Diagnostics	Version: 1.1
Software Requirements Specification	Date: 8/28/2003
<document identifier>	

Variable	Definition	Values
<b>Boiler_Off_Date_dDown</b>	The number of days before the Boiler_Off_Date that the boiler may be turned off without the boiler operation considered to be in error (i.e., it should be on).	Number of days
<b>Boiler_Off_Date_dUp</b>	The number of days beyond the Boiler_Off_Date that the boiler may be on before the boiler operation is considered to be in error (i.e., it should be off).	Number of days
<b>Boiler_On_Date</b>	Numeric value for the day of the year on which the boiler is normally turned on for the heating season with the days of the year numbered consecutively; e.g., October 31 is day 304 for a non-leap year.	Numerical value for day of year.
<b>Boiler_On_Date_dDown</b>	The number of days before the Boiler_On_Date that the boiler may be turned on without the boiler operation considered to be in error (i.e., it should be off).	Number of days
<b>Boiler_On_Date_dUp</b>	The number of days beyond the Boiler_On_Date that the boiler may be off before the boiler operation is considered to be in error (i.e., it should be on).	Number of days
<b>Boiler_On_Threshold_Electric</b>	The electric current threshold above which an electric boiler is considered "On."	Electric current in amps or null. Real.
<b>Boiler_On_Threshold_Electric_P</b>	Fraction of Boiler_Capacity selected for the "On" Threshold for electric boilers (e.g. 0.01)	Dimensionless real number between 0.0 and 1.0 (e.g., 0.01)
<b>Boiler_On_Threshold_Fossil</b>	The hot water supply temperature above which a fossil fuel-fired boiler is considered "On."	Temperature in degrees F or null. Real.
<b>Boiler_Schedule_Type</b>	An indicator of the type of boiler schedule. It can take values of "Ambient Shutoff," "Manual Shutoff," and "Always On."	"Ambient Shutoff," "Manual Shutoff," or "Always On."

Automated Diagnostics	Version: 1.1
Software Requirements Specification	Date: 8/28/2003
<document identifier>	

Variable	Definition	Values
<b><i>Boiler_Shutoff_OK/Not</i></b>	A variable that indicates whether shut off of the boiler is controlled properly for and consistently with the type of boiler.	"OK. The boiler is on as it should be. Shutoff is not applicable to this boiler. The boiler system is designed for continuous operation." "Not OK; the boiler is off and it should be on always, unless it is locked out temporarily for maintenance or repair." "OK; the boiler is on as it should be." "OK; the boiler is off as it should be" "Not OK; the boiler is off when it should be on." "Not OK; the boiler is on when it should be off." "Ok; the date is too close to the Boiler On Date to evaluate compliance with the schedule." "Ok; the date is too close to the Boiler Off Date to evaluate compliance with the schedule."
<b><i>Boiler_Stage_Power</i></b>	The electric power to the boiler heating elements at the current time. Does not include auxiliary power such as valves and fans.	Electric power in watts. Real.
<b><i>Boiler_Status</i></b>	A variable indicating whether the boiler is on or off.	On or Off.
<b><i>Boiler_Status(nt * TimeStep)</i></b>	Boiler_Status at the time (nt * TimeStep). The variable nt takes values less than or equal to zero.	On or Off.
<b><i>BSNumber</i></b>	A numerical indicator of the Boiler_Status, where Boiler_Status = "on" corresponds to BSNumber = 1, and Boiler_Status = "Off" corresponds to BSNumber = 0.	0 or 1
<b><i>Current_Date</i></b>	A numerical indicator of the current date corresponding to the current processing time, counting from January 1 of each year.	Date
<b><i>Current_Time</i></b>	The absolute time of the current time step.	Time in minutes.

Automated Diagnostics	Version: 1.1
Software Requirements Specification	Date: 8/28/2003
<document identifier>	

Variable	Definition	Values
<b>Cycle_Counts</b>	An local variable used to keep count of the number of complete on/off cycles during a designated time period.	Integer values.
<b>Design_HWST</b>	Design hot-water supply temperature.	Temperature in degrees F. Real.
<b>FHWST_High</b>	Fraction of HWST-SP_Maintained_OK/Not equal to "Too High" over the last HWST_Too_High_Window	Real value between 0.0 and 1.0.
<b>FHWST_High_Limit</b>	The fraction of "Too High" hot water supply temperature observations over the designated time window for which the long-term HWST is judged too high.	Real value between 0.0 and 1.0.
<b>FHWST_Low</b>	Fraction of HWST-SP_Maintained_OK/Not equal to "Too Low" over the last HWST_Too_Low_Window.	Real value between 0.0 and 1.0.
<b>FHWST_Low_Limit</b>	The fraction of "Too Low" hot water supply temperature observations over the designated time window for which the long-term HWST is judged too low.	Real value between 0.0 and 1.0.
<b>HW_Pump_Current</b>	The measured value of current for the hot-water pump	Current in amps.
<b>HW_Pump_On_Threshold</b>	The value of hot-water pump current (HW_Pump_Current) above which the pump is considered on.	Current in amps.
<b>HW_Pump_Last_Status</b>	The value of the HW_Pump_Status one time step ago (i.e., the processing time before the current time).	"On" or "Off"
<b>HW_Pump_Motor_Rated_Current</b>	Current rating of the hot-water pump motor from the motor nameplate.	Current in amps.
<b>HW_Pump_P</b>	Fraction of Hot-Water pump rated current selected for the "On" Threshold.	Dimensionless real number between 0.0 and 1.0.
<b>HW_Pump_Run_Limit</b>	The maximum time interval after the boiler turns off during which the hot-water pump can run. After this time, the hot-water pump should not turn on again until the boiler turns on.	Time interval in hours.

Automated Diagnostics	Version: 1.1
Software Requirements Specification	Date: 8/28/2003
<document identifier>	

Variable	Definition	Values
<b><i>HW_Pump_Shutoff_OK/Not</i></b>	A variable indicator whether the On/Off status of the hot-water pump is being controlled properly or not, and if not, how is it's control wrong.	"OK; the hot-water pump is off as it should be." "OK; the hot water pump is on while the boiler is on." "Hot Water Pumping Fault; the pump is off too much while the boiler is on." "HW Pump is running unnecessarily and wasting energy and useful operating life." "OK; the hot-water pump is running while the boiler is off, but the hot-water run limit has not been exceeded yet."
<b><i>HW_Pump_Status</i></b>	A variable indicating whether the hot-water pump is on or off.	"On" or "Off"
<b><i>HWST</i></b>	Hot-water supply temperature	Temperature in degrees F.
<b><i>HWST_dDown</i></b>	Maximum acceptable deviation of the hot-water supply temperature below its set point for a single measurement.	Temperature in degrees F.
<b><i>HWST_Deviation</i></b>	The hot water supply temperature deviation from set point for the current observation. [Note: This output is included only for consistency with the chilled water reset diagnostic and may not be needed.]	Temperature difference in degrees F.
<b><i>HWST_dUp</i></b>	Maximum acceptable deviation of the hot-water supply temperature above its setpoint for a single measurement.	Temperature in degrees F.
<b><i>HWST_Maintained_OK/Not</i></b>	Hot Water Supply Temperature Status Message. Possible values: "OK," "Too high," "Too Low."	Ok. Too high. Too low.

Automated Diagnostics	Version: 1.1
Software Requirements Specification	Date: 8/28/2003
<document identifier>	

Variable	Definition	Values
<b><i>HWST_Maintained_OK/not_Too-Low_Array</i></b>	The array: {HWST_Maintained_OK/not, HWST_Maintained_OK/not (1 time step ago), HWST_Maintained OK/not (2 time steps ago), HWSTMaintained_OK/not (3 time steps ago), HWST_Maintained-OK/not (4 time steps ago), ...HWST_Maintained_OK/not [(HWST_Too_Low_Window – 1) time steps ago]}	Array with individual elements takings values of Ok, Too High, or Too Low.
<b><i>HWST_Maintained_OK/not_Too-High_Array</i></b>	The array: {HWST_Maintained_OK/not, HWST_Maintained_OK/not (1 time step ago), HWST_Maintained OK/not (2 time steps ago), HWSTMaintained_OK/not (3 time steps ago), HWST_Maintained-OK/not (4 time steps ago), .HWST_Maintained_OK/not [(HWST_Too_High_Window – 1) time steps ago]}	Array with individual elements takings values of Ok, Too High, or Too Low.
<b><i>HWSTNumber_High</i></b>	HWSTNumber High is the number of values of the variable HWST_Maintained_OK/not with values of “Too High” during the last HWST_Too_High_Window time steps.	Integer.
<b><i>HWSTNumber_Low</i></b>	HWSTNumber Low is the number of values of the variable HWST_Maintained_OK/not with values of “Too Low” during the last HWST_Too_Low_Window time steps.	Integer.
<b><i>HWST_Setpoint-Current</i></b>	Hot-water supply temperature setpoint for the current time.	Temperature in degrees F.
<b><i>HWST-SP_Maintained_OK/Not</i></b>	An indicator of whether the hot-water supply temperature is adequately maintained at a single point in time.	OK Too high Too low
<b><i>HWST_Too_High_Window</i></b>	Length in number of observations of the moving time window over which the percentage of too high hot water supply temperatures is evaluated.	Number of time steps. Integer
<b><i>HWST_Too_Low_Window</i></b>	Length in number of observations of the moving time window over which the percentage of too low hot water supply temperatures is evaluated.	Number of time steps. Integer

Automated Diagnostics	Version: 1.1
Software Requirements Specification	Date: 8/28/2003
<document identifier>	

Variable	Definition	Values
<b><i>Latest_Complete_Boiler_Off_Duration</i></b>	The length of time over which the boiler was off the last time it went through a complete off-cycle (i.e., from on to off to on again).	Time interval in minutes.
<b><i>Latest_Complete_Boiler_On_Duration</i></b>	The length of time over which the boiler was on the last time it went through a complete on-cycle (i.e., from off to on to off again).	Time interval in minutes.
<b><i>Max_Normal_Boiler_CPH</i></b>	A setup variable for the maximum number of cycles that the boiler should go through in an hour.	Positive integer.
<b><i>Min_Normal_Boiler_Off_Duration</i></b>	A setup variable that indicates the minimum time the boiler should be off before turning on again.	Time interval in minutes.
<b><i>Min_Normal_Boiler_On_Duration</i></b>	A setup variable that indicates the minimum time the boiler should be on before shutting off again.	Time interval in minutes.
<b><i>Nmax</i></b>	Number of times steps per hour = $60/\text{TimeStep}$ = the rounded number of calculation time steps per hour given the length of the time step designated during set up.	Positive integer.
<b><i>nt</i></b>	An index for the number of time steps.	Integer, usually less than or equal to zero.
<b><i>TimeStep</i></b>	A setup variable for the length of time between successive processings in minutes (which is assumed constant).	Time increment in minutes.
<b><i>Time_Steps_Processed</i></b>	Total number of time steps processed since the beginning of processing.	Integer.